



Non-Invasive Scanning and Subtle Energy Testing Lab Effect of LifeWave X39™ Patches on Brain as Seen with P3 Brain Mapping: Preliminary Results

Principal Investigator: Gaétan Chevalier, Ph.D., Research Director (Bio in Appendix A)

Co-Investigator: Mary D. Clark, Ph.D., Managing Director (Bio in Appendix B)

Abstract: Brain mapping measurements were performed on twelve (12) healthy older adult participants before, after 3 weeks and after 6 weeks of use of Lifewave X39™ patches 12 hours a day. All participants showed dramatic changes in their scalp topographic maps reporting the amplitude of the P300 recording for each channel and also in their coherence maps. According to their coherence maps, the majority of participants started with an over active brain and their brain calmed down significantly after 3 weeks of wearing the X39™ patch. Several participants reported various notable improvements and most participants reported feeling slightly better or a lot better at the end of their participation. There was a statistically significant increase in physical reaction time at Session 2 that may be due to the effect of the X39™ patch on the physiology of the participants. The fact that the physical reaction time returned to the initial average value after 6 weeks suggests that there is a temporary physiological effect due to the X39™ patch that readjusts itself to a normal level within a 6-week period. The significantly lower average values of Audio P300 Voltage at Session 2 and at Session 3 compared to Session 1, coupled with the coherence results, suggest that the initial Audio P300 Voltage was high and reflects a hyperactive brain. Application of a X39™ patch for 3 weeks brought the Audio P300 Voltage to a normal level and that level stayed normal until the end of the 6-week duration of the study.

Goal: This is a pilot project using brain mapping to assess any differences in brain function after using Lifewave X39™ for 6 weeks.

Statement of Work: Brain mapping measurements were performed on twelve (12) healthy older adult participants before, after 3 weeks and after 6 weeks of use of Lifewave X39™ patches 12 hours a day as recommended by the Sponsor. Additionally, we monitored mood and well-being levels of each subject at each brain mapping measurement using well accepted psychological tests. The Brief Mood Introspection Scale (BMIS) was used for mood and the Arizona Integrated Outcome Visual Analog Scale (AIO-VAS) for well-being.

Equipment: Sponsor provided Lifewave X39™ patches with detailed information on how to use them (location on the body, duration for the use of the patch, frequency of patches replacement, etc.). The brain mapping equipment used for this project was the p3 Baseline brain mapping system (www.p3baseline.com), a non-invasive commercially available device that is FDA cleared for use in routine clinical and research settings.

Participants Selection: To be accepted in the study, potential participants were required to comply with the following criteria:



Non-Invasive Scanning and Subtle Energy Testing Lab

- Healthy adult between the ages 50 and 80 years old;
- No mental disorder;
- Did not receive treatment for mental disorder or taken psychotropic medication within the past 2 years;
- No prescribed medication taken (less than two months prior to participation);
- No cardiovascular or pulmonary condition such as asthma or heartbeat irregularities;
- No use of recreational drugs, cigarettes or vaping;
- No simultaneous participation in any other research project;
- No previous utilization of LifeWave X39™ Patches;
- No consumption of alcohol within 48 hours of participation;
- No food, caffeine or other stimulants within 2 hours prior of participation
- Agree and able to wear a patch for 12 hours daily for 6 weeks
- Commit to come to Psy-Tek lab 3 times (each appointment was approx. 2 hours)

Procedure and Methodology

Once a potential participant met all the inclusion criteria, an appointment was set up to have the participant come to the lab for the first testing. Once at Psy-Tek Labs, the participant had the opportunity to ask questions and when all questions were answered the participant signed the consent form. At the beginning of each visit, each participant was asked to fill two questionnaires: one about mood (Brief Mood Introspection Scale or BMIS) and the other about well-being (Arizona Integrated Outcome Visual Analog Scale or AIO-VAS). Next, the technician ran the following brain scan tests:

- P300 Eyes Closed Auditory ERP (provides measures of cognitive response)
- Eyes Opened Focused Test (EEG measurement of brain wave patterns)
- Flanker Test (Eriksen flanker test provides a measure of cognitive control)
- 2 Trail Making Tests (provides a measure of visual control and task switching)

In all, brain mapping measurements were performed on each participant 3 times: before, after 3 weeks and after 6 weeks of use of LifeWave X39™ patches for 12 hours a day as recommended by the Sponsor. After all measurements were done at the last visit, participants filled a final questionnaire, the Overall Wellness Assessment Form.

Non-Invasive Scanning and Subtle Energy Testing Lab

Results

Participant 1

Female, 77, Yoga instructor. During the entire experiment she placed the X39™ patch at the back of middle neck. At her first visit she indicated that her sense of well-being was very high (100%) on the AIO-VAS (0 = worst you have ever been; 100% = best you have ever been) and her mood was +10 according to the BMIS (the BMIS scale goes from -10 = very unpleasant to +10 = very pleasant). The AIO-VAS and the BMIS scores were the same also at her second visit and her third and final visit. At her third visit she indicated that her discipline in doing her morning exercises and meditation greatly improved. She also indicated that she had vivid dreams during the experiment. In the Overall Wellness Assessment Form (always filled at the end of their participation) she indicated that she felt slightly better than usual at her first visit, and a lot better than usual at her second and third visits.

Scalp Topography Map

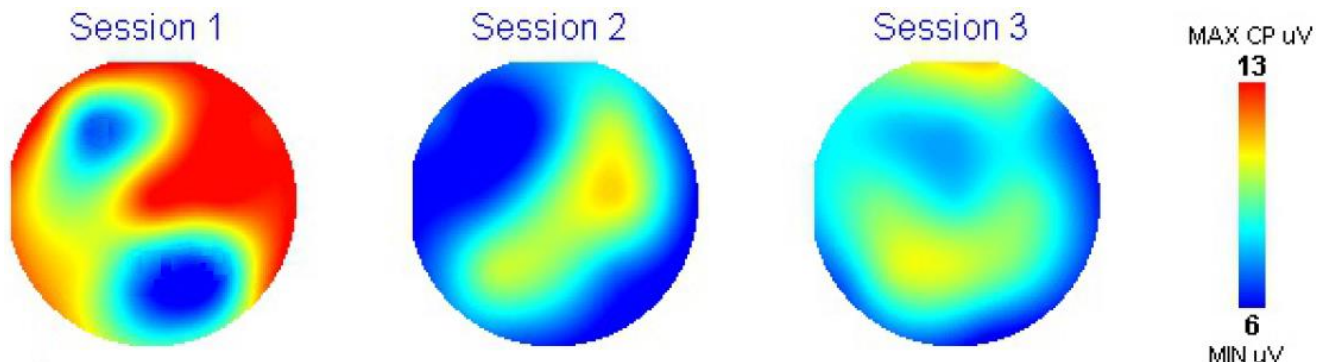

These scalp topographical maps were computed from the 19 EEG channels recorded by the brain mapping system (frontal part of the brain at the top and back of the head at the bottom of each circle). These maps show the amplitude of the P300 recording for each channel (in microvolts or μV) using a color-coding scale presented on the right side referenced to Session 3 (red is for the maximum amplitude of 13 μV and dark blue for the minimum amplitude of 6 μV). It can be noted that when she came in, her brain was hyperactive. Her brain calmed down dramatically at the second visit (Session 2), after wearing the X39™ patch for 3 weeks. Her brain remained calm after wearing the patch for 6 weeks (Session 3).

Non-Invasive Scanning and Subtle Energy Testing Lab

Coherence

P300 Eyes Closed Z Scores

Band Ranges
 Theta: 4.5–7.5 Hz
 Alpha: 8.0–13.0 Hz
 Beta: 13.5–20.0 Hz

Color Key



THETA

ALPHA

BETA

Session 1

Z-Scores above 2.0 and below -2.0

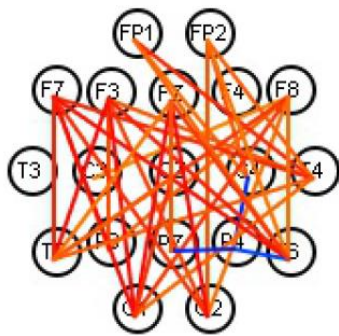

-COHERENCE-

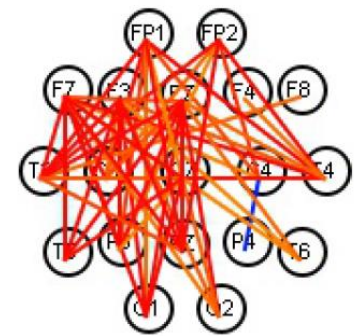
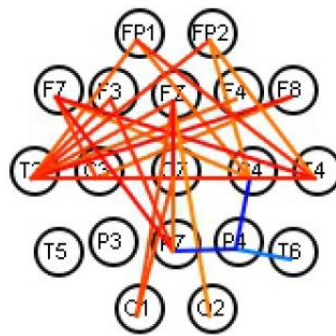

Session 2

Z-Scores above 2.0 and below -2.0

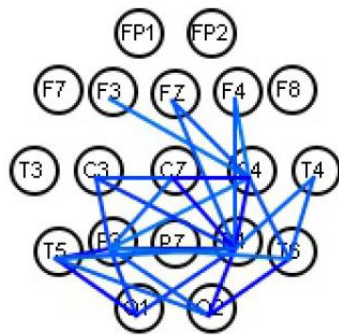

-COHERENCE-

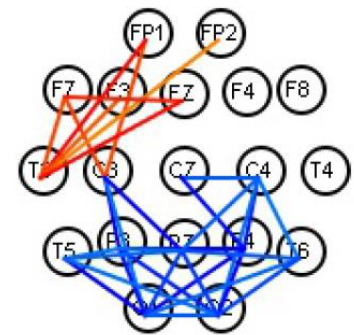
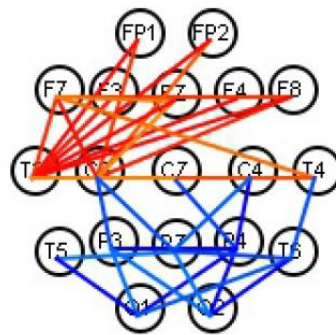

Session 3

Z-Scores above 2.0 and below -2.0

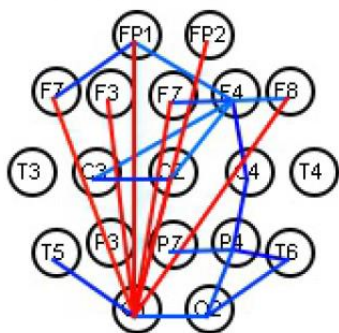

-COHERENCE-

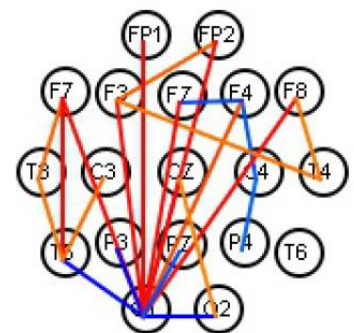
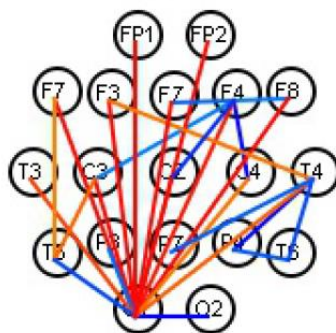



Non-Invasive Scanning and Subtle Energy Testing Lab

The coherence diagrams above show a perspective where we are looking down at the top of the head from above (FP1 and FP2 are on the forehead while O1 and O2 are at the back of the head). EEG coherence can be defined as the normalized cross-power spectrum per frequency of two signals recorded simultaneously at different sites of the scalp. It is a measure of the synchronization between the two signals and may be interpreted as an expression of their functional interaction (1). Coherence reflects how stable the phase relationship is between two electrode sites. Coherence quantifies the degree of interaction or communication, shared information, between brain sites. Hypercoherence is when brain sites are not functioning in efficient interdependent fashion, they have too much “cross-talk”, they are overly connected or locked together. Hypocoherence is called poor inter-site interaction and is associated with diminished cognitive efficiency (2). The red lines between two sites indicate hypercoherence while blue lines reflect hypocoherence. Beta brain waves are normally dominant in a person awake, alert, with normal level of consciousness and brain function. Alpha become dominant in a person with eyes closed, calm, aware and quietly alert. Theta brain waves show up in deep relaxation, meditation and mental imagery (3). Participants were awake with eyes closed during these measurements and so the most relevant results are those presented in the Alpha (relaxation) and Beta (normal brain activity) bands.

At the beginning of her participation (Session 1), Participant 1 had most of her brain sites in hypercoherence for all 3 frequency bands (Beta, Alpha and Theta). After wearing the X39™ patch for 3 weeks (Session 2), most of the frontal part of the brain was still in hypercoherence (mainly in Alpha) and after wearing the X39™ patch for 6 weeks (Session 3) there was less hypercoherence that was more evenly distributed both among brain sites and frequency bands.

Screening Scores

Screening Scores	Session 1	Session 2	Session 3	Target Range
Performance Assessments				
Physical Reaction Time	317 (±46) ms	343 (±39) ms	343 (±53) ms	287–413 ms
Trail Making Test A	75 sec	62 sec	78 sec	86–147 sec
Trail Making Test B	119 sec	82 sec	128 sec	83–160 sec
Evoked Potentials				
Audio P300 Delay	▣ 308 ms	▣ 344 ms	316 ms	313–407 ms
Test/Retest Change	-	36 ms	8 ms	±11 ms
Audio P300 Voltage	▣▽ 17.3 µV	▣ 11.4 µV	10.9 µV	6–14 µV
Test/Retest Change	-	-6 µV	-6 µV	±2 µV
State				
CZ Eyes Closed Theta/Beta (Power)	▣ 1.7	1.6	2.5	0.6–1.4
F3/F4 Eyes Closed Alpha (Magnitude)	0.7	0.8	1.0	0.9–1.1

Symbol Key: ▣ = Possible Artifact, ▽ = Sync Blinks



Non-Invasive Scanning and Subtle Energy Testing Lab

The goal is for each screening score to be inside the target range. If a score is below or above the target range it is considered abnormal (too fast if below or too slow if above the target time). An explanation of each screening score follows. These explanations are provided by p3baseline (www.p3baseline.com).

Physical Reaction time

It is a measure of speed in response to an audible odd tone. This relies on different pathways than the Auditory P300, so physical reaction time may be different than the brain speed.

Trail Making

A standard measure of brain function and includes measures of psychomotor and visual scanning.

Evoked Potentials - Auditory P300

Auditory P300 is a measure of brain response speed and attentional resources. P300 slowing and/or a reduction in voltage may signal changes in cognitive function.

State - CZ Theta/Beta

Theta and Beta frequency bands are affected by cortical arousal and can give insight into how the brain functions. In some people high Theta/Beta ratios at CZ may present as inattention, while others may benefit from cortical arousal.

Researchers have shown that calculating the relative power ratio Theta/Beta at CZ can be used to determine slow-wave disorders, ADHD, interpersonal detachment with qualitative aspects of autistic or Asperger's behavior (3, 4, 5).

State - F3/F4 Alpha

Large differences in Alpha power between the left-front and right-front of the brain have been associated with depression and/or anxiety.

Researchers also discovered that calculating F3/F4 relative power ratio in the Alpha band means processing information in a positive way for an increase while a decrease in the ratio indicated a more negative processing mode (6, 7).

Non-Invasive Scanning and Subtle Energy Testing Lab

Participant 2

Female, 67, manual therapist, specializing in craniosacral and massage. She indicated that she has pain in bones, joint, or muscles that is aggravated by exercise. During her participation in the study she placed the patch 3 inches below the navel. At her first visit her sense of well-being on the AIO-VAS was at 71% VAS (0 = worst you have ever been; 100% = best you have ever been) and her mood at +9 on the BMIS (the BMIS scale goes from -10 = very unpleasant to +10 = very pleasant). At her second visit she indicated that her well-being score on the AIO-VAS was 57% and her mood was +5 on the BMIS scale. At her third and final visit she indicated that her well-being score was 63% and her BMIS mood score was +8. In the Overall Wellness Assessment Form, she indicated that she felt slightly better than usual at all 3 visits.

Scalp Topography Map

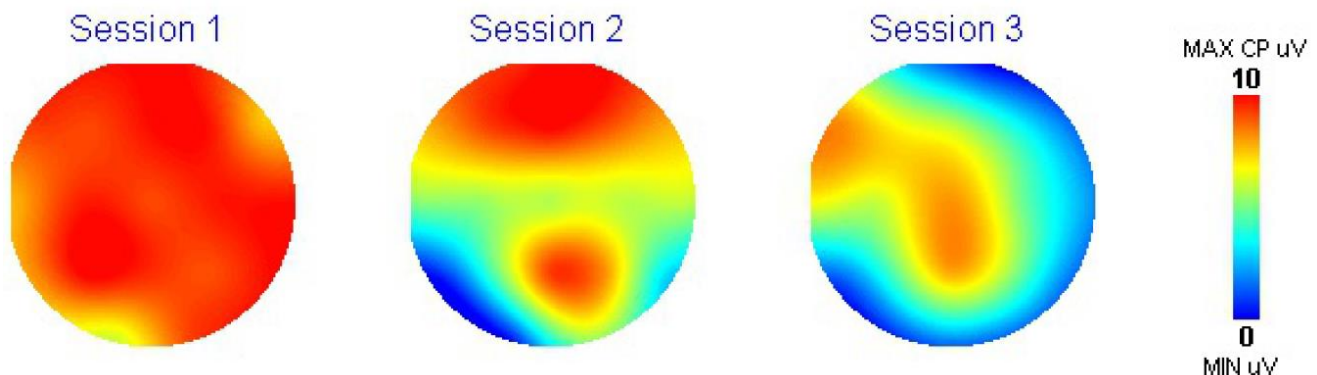

These scalp topographical maps were computed from the 19 EEG channels recorded by the brain mapping system. These maps show the amplitude of the P300 recording for each channel (in microvolts or μV) using a color-coding scale presented on the right side referenced to Session 3 (red is for the maximum amplitude of 10 μV and dark blue for the minimum amplitude of 0 μV). It can be noted that when she came in, her brain was hyperactive. Her brain calmed down dramatically at the second visit (Session 2), after wearing the X39™ patch for 3 weeks and became even calmer after wearing the X39™ patch for 6 weeks (Session 3).

Non-Invasive Scanning and Subtle Energy Testing Lab

Coherence

P300 Eyes Closed Z Scores

Band Ranges
 Theta: 4.5–7.5 Hz
 Alpha: 8.0–13.0 Hz
 Beta: 13.5–20.0 Hz

Color Key



THETA

ALPHA

BETA

Session 1

Z-Scores above 2.0 and below -2.0

-COHERENCE-

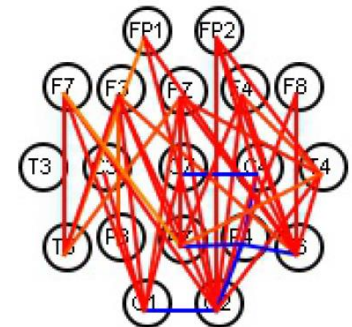
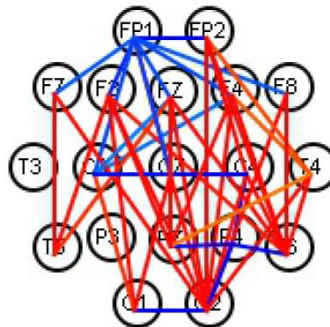
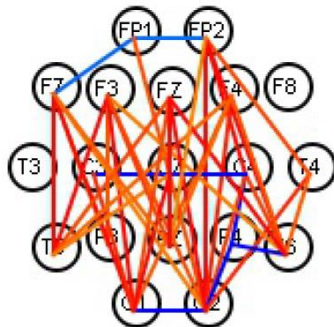

Session 2

Z-Scores above 2.0 and below -2.0

-COHERENCE-

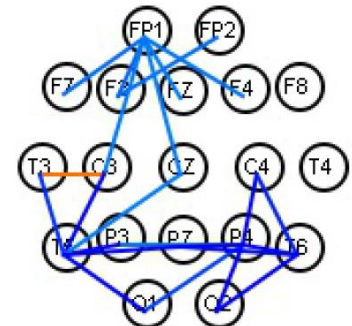
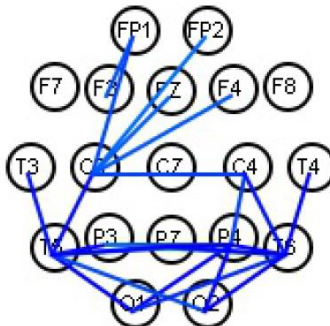
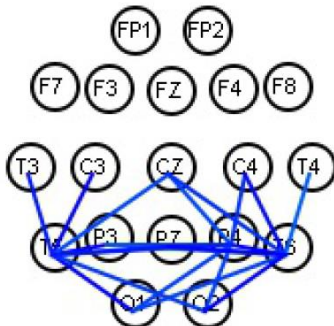

Session 3

Z-Scores above 2.0 and below -2.0

-COHERENCE-

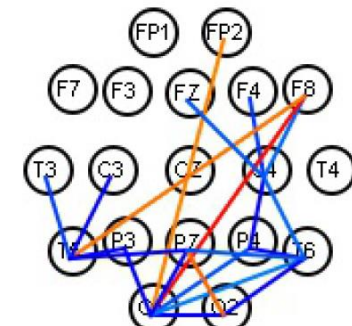
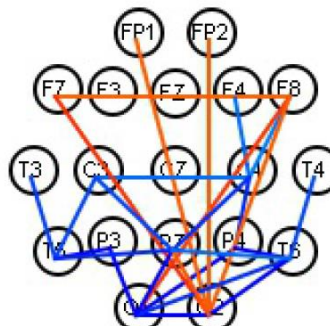
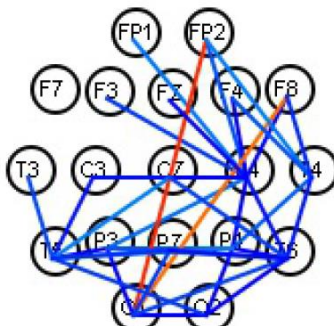



Non-Invasive Scanning and Subtle Energy Testing Lab

EEG coherence can be defined as the normalized cross-power spectrum per frequency of two signals recorded simultaneously at different sites of the scalp. It is a measure of the synchronization between the two signals and may be interpreted as an expression of their functional interaction (1). Coherence reflects how stable the phase relationship is between two electrode sites. Coherence quantifies the degree of interaction or communication, shared information, between brain sites. Hypercoherence is when brain sites are not functioning in efficient interdependent fashion, they have too much “cross-talk”, they are overly connected or locked together. Hypocoherence is called poor inter-site interaction and is associated with diminished cognitive efficiency (2). The red lines between two sites indicate hypercoherence while blue lines reflect hypocoherence. Beta brain waves are normally dominant in a person awake, alert, with normal level of consciousness and brain function. Alpha become dominant in a person with eyes closed, calm, aware and quietly alert. Theta brain waves show up in deep relaxation, meditation and mental imagery (3). Participants were awake with eyes closed during these measurements and so the most relevant results are those presented in the Alpha (relaxation) and Beta (normal brain activity) bands.

At the beginning of her participation (Session 1), Participant 2 had most of her brain sites in hypercoherence for all 3 frequency bands (Beta, Alpha and Theta). After wearing the X39™ patch for 3 weeks (Session 2), there was some level of hypocoherence mainly in the back of the head for all 3 frequency bands and after wearing the X39™ patch for 6 weeks (Session 3) there was much less hypercoherence than at the beginning of her participation and both hyper and hypo coherence between sites were less frequent and more evenly distributed among brain sites and frequency bands.

Screening Scores

Screening Scores	Session 1	Session 2	Session 3	Target Range
Performance Assessments				
Physical Reaction Time	356 (±55) ms	355 (±37) ms	392 (±33) ms	268–386 ms
Trail Making Test A	80 sec	99 sec	91 sec	67–115 sec
Trail Making Test B	168 sec	110 sec	122 sec	65–125 sec
Evoked Potentials				
Audio P300 Delay	332 ms	336 ms	360 ms	295–383 ms
Test/Retest Change	-	4 ms	28 ms	±11 ms
Audio P300 Voltage	15.8 µV	9.4 µV	7.0 µV	6–15 µV
Test/Retest Change	-	-6 µV	-9 µV	±2 µV
State				
CZ Eyes Closed Theta/Beta (Power)	0.6	0.5	0.7	0.6–1.5
F3/F4 Eyes Closed Alpha (Magnitude)	0.9	1.0	1.0	0.9–1.1

Symbol Key: ■ = Possible Artifact, ▽ = Sync Blinks

The goal is for each screening score to be inside the target range. If a score is below or above the target range it is considered abnormal (too fast if below or too slow if above the



Non-Invasive Scanning and Subtle Energy Testing Lab

target time). An explanation of each of screening score follows. These explanations are provided by p3baseline (www.p3baseline.com).

Physical Reaction time

It is a measure of speed in response to an audible odd tone. This relies on different pathways than the Auditory P300, so physical reaction time may be different than the brain speed.

Trail Making

A standard measure of brain function and includes measures of psychomotor and visual scanning.

Evoked Potentials - Auditory P300

Auditory P300 is a measure of brain response speed and attentional resources. P300 slowing and/or a reduction in voltage may signal changes in cognitive function.

State - CZ Theta/Beta

Theta and Beta frequency bands are affected by cortical arousal and can give insight into how the brain functions. In some people high Theta/Beta ratios at CZ may present as inattention, while others may benefit from cortical arousal.

Researchers have shown that calculating the relative power ratio Theta/Beta at CZ can be used to determine slow-wave disorders, ADHD, interpersonal detachment with qualitative aspects of autistic or Asperger's behavior (3, 4, 5).

State - F3/F4 Alpha

Large differences in Alpha power between the left-front and right-front of the brain have been associated with depression and/or anxiety.

Researchers also discovered that calculating F3/F4 relative power ratio in the Alpha band means processing information in a positive way for an increase while a decrease in the ratio indicated a more negative processing mode (6, 7).

Participant 3

Female, 68, real estate broker. She indicated that she has high blood pressure and that she experiences problems or pain in her bones, joints, or muscles. She also has swelling of the ankles or lower extremities. For the entire duration of her participation she placed the patch

Non-Invasive Scanning and Subtle Energy Testing Lab

in the middle of the neck. At her first visit she indicated that her sense of well-being was 77% on the AIO-VAS (0 = worst you have ever been; 100% = best you have ever been) and her mood was +8 according to the BMIS (the BMIS scale goes from -10 = very unpleasant to +10 = very pleasant). At her second visit, her AIO-VAS score changed a bit to 57% and the BMIS score became +9. At her third visit her AIO-VAS score increased to 63% and her BMIS score stayed at +9. She indicated that overall she was able to work out harder, with more stamina, without muscle cramps, feeling better about workouts with less pain. She also indicated that she is more even keeled, mentally alert, sharp and that her skin is a little dryer. The Overall Wellness Assessment form indicated that she felt slightly better than usual at the beginning of her participation and after 3 weeks into her participation but that she felt a lot better at the end of her participation.

Scalp Topography Map

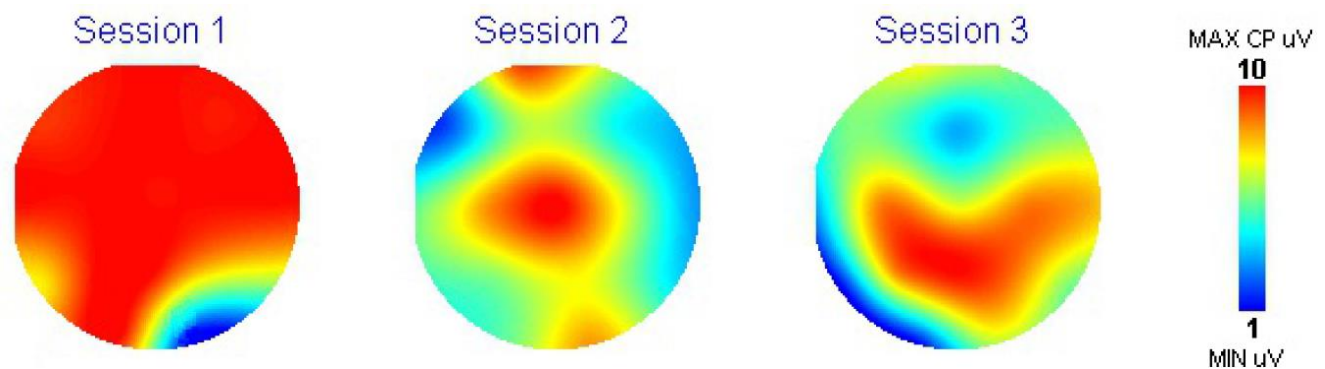

These scalp topographical maps were computed from the 19 EEG channels recorded by the brain mapping system. These maps show the amplitude of the P300 recording for each channel (in microvolts or μV) using a color-coding scale presented on the right side referenced to Session 3 (red is for the maximum amplitude of 10 μV and dark blue for the minimum amplitude of 1 μV). It can be noted that when she came in, her brain was hyperactive. Her brain calmed down dramatically at the second visit (Session 2), after wearing the X39™ patch for 3 weeks and her brain remained calm after wearing the X39™ patch for 6 weeks (Session 3).

Non-Invasive Scanning and Subtle Energy Testing Lab

Coherence

P300 Eyes Closed Z Scores

Band Ranges
 Theta: 4.5–7.5 Hz
 Alpha: 8.0–13.0 Hz
 Beta: 13.5–20.0 Hz

Color Key



THETA

ALPHA

BETA

Session 1

Z-Scores above 2.0 and below -2.0

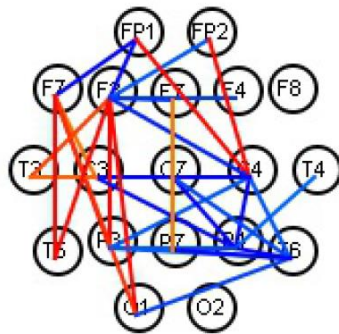

-COHERENCE-

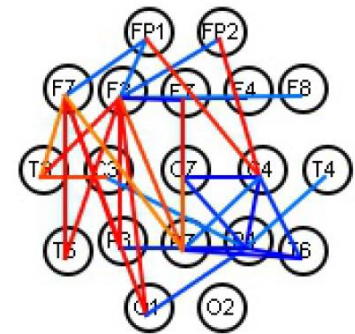
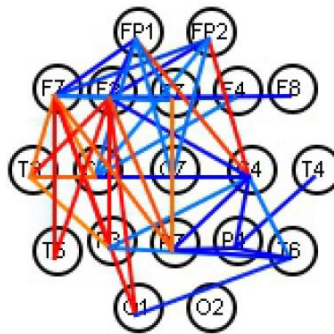

Session 2

Z-Scores above 2.0 and below -2.0

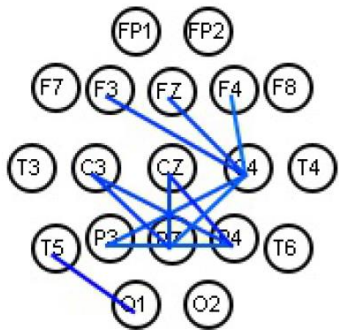

-COHERENCE-

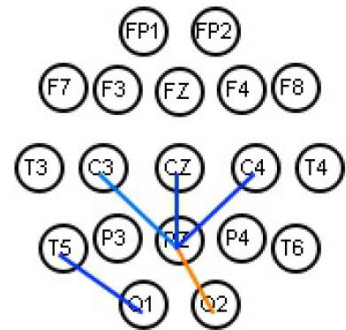
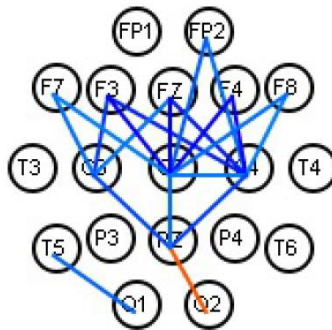

Session 3

Z-Scores above 2.0 and below -2.0

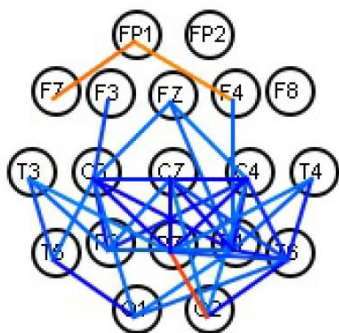

-COHERENCE-

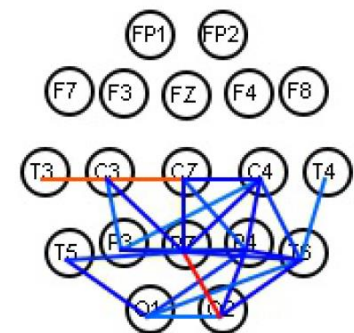
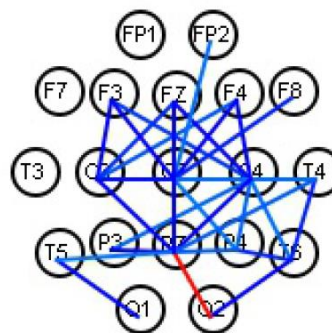



Non-Invasive Scanning and Subtle Energy Testing Lab

EEG coherence can be defined as the normalized cross-power spectrum per frequency of two signals recorded simultaneously at different sites of the scalp. It is a measure of the synchronization between the two signals and may be interpreted as an expression of their functional interaction (1). Coherence reflects how stable the phase relationship is between two electrode sites. Coherence quantifies the degree of interaction or communication, shared information, between brain sites. Hypercoherence is when brain sites are not functioning in efficient interdependent fashion, they have too much “cross-talk”, they are overly connected or locked together. Hypocoherence is called poor inter-site interaction and is associated with diminished cognitive efficiency (2). The red lines between two sites indicate hypercoherence while blue lines reflect hypocoherence. Beta brain waves are normally dominant in a person awake, alert, with normal level of consciousness and brain function. Alpha become dominant in a person with eyes closed, calm, aware and quietly alert. Theta brain waves show up in deep relaxation, meditation and mental imagery (3). Participants were awake with eyes closed during these measurements and so the most relevant results are those presented in the Alpha (relaxation) and Beta (normal brain activity) bands.

At the beginning of her participation (Session 1), Participant 3 had a mix of hypercoherence and hypocoherence at all 3 frequency bands (Beta, Alpha and Theta). After wearing the X39™ patch for 3 weeks (Session 2), there was some level of hypocoherence mainly in the middle of the head for Alpha and Theta frequency bands. After wearing the X39™ patch for 6 weeks (Session 3) there was almost no hypercoherence and a little more hypocoherence links mainly at the occipital (back) region of the head.

Screening Scores

Screening Scores	Session 1	Session 2	Session 3	Target Range
Performance Assessments				
Physical Reaction Time	297 (±38) ms	296 (±37) ms	303 (±43) ms	270–388 ms
Trail Making Test A	66 sec	62 sec	81 sec	69–118 sec
Trail Making Test B	133 sec	108 sec	110 sec	66–128 sec
Evoked Potentials				
Audio P300 Delay	344 ms	332 ms	332 ms	297–385 ms
Test/Retest Change	-	-12 ms	-12 ms	±11 ms
Audio P300 Voltage	∇ 23.1 µV	9.6 µV	9.8 µV	6–15 µV
Test/Retest Change	-	-13 µV	-13 µV	±2 µV
State				
CZ Eyes Closed Theta/Beta (Power)	1.7	1.9	1.5	0.6–1.5
F3/F4 Eyes Closed Alpha (Magnitude)	1.1	1.0	1.0	0.9–1.1
Symbol Key: ■ = Possible Artifact, ∇ = Sync Blinks				

The goal is for each screening score to be inside the target range. If a score is below or above the target range it is considered abnormal (too fast if below or too slow if above the target time). An explanation of each of screening score follows. These explanations are provided by p3baseline (www.p3baseline.com).



Non-Invasive Scanning and Subtle Energy Testing Lab

Physical Reaction time

It is a measure of speed in response to an audible odd tone. This relies on different pathways than the Auditory P300, so physical reaction time may be different than the brain speed.

Trail Making

A standard measure of brain function and includes measures of psychomotor and visual scanning.

Evoked Potentials - Auditory P300

Auditory P300 is a measure of brain response speed and attentional resources. P300 slowing and/or a reduction in voltage may signal changes in cognitive function.

State - CZ Theta/Beta

Theta and Beta frequency bands are affected by cortical arousal and can give insight into how the brain functions. In some people high Theta/Beta ratios at CZ may present as inattention, while others may benefit from cortical arousal.

Researchers have shown that calculating the relative power ratio Theta/Beta at CZ can be used to determine slow-wave disorders, ADHD, interpersonal detachment with qualitative aspects of autistic or Asperger's behavior (3, 4, 5).

State - F3/F4 Alpha

Large differences in Alpha power between the left-front and right-front of the brain have been associated with depression and/or anxiety.

Researchers also discovered that calculating F3/F4 relative power ratio in the Alpha band means processing information in a positive way for an increase while a decrease in the ratio indicated a more negative processing mode (6, 7).

Participant 4

Male, 73, retired CPA. For the entire duration of his participation he placed the patch three inches below the navel. At his first visit he indicated that his sense of well-being was 48% on the AIO-VAS (0 = worst you have ever been; 100% = best you have ever been) and his mood was +1 according to the BMIS (the BMIS scale goes from -10 = very unpleasant to +10

Non-Invasive Scanning and Subtle Energy Testing Lab

= very pleasant). At his second visit, her AIO-VAS score changed a bit to 70% and the BMIS score became +3. At his third visit his AIO-VAS score decreased to 20% and his BMIS score decreased to -7. He indicated that he had concerns about possible permanent brain damage from a concussion that happened to him several years ago. The Overall Wellness Assessment form indicated that his feeling was as usual for the entire time of participation.

Scalp Topography Map

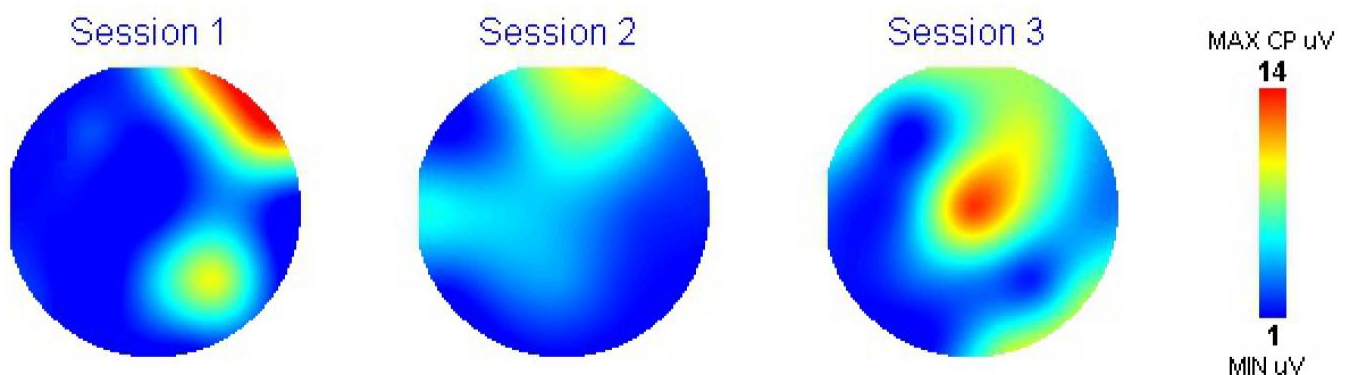

These scalp topographical maps were computed from the 19 EEG channels recorded by the brain mapping system. These maps show the amplitude of the P300 recording for each channel (in microvolts or μV) using a color-coding scale presented on the right side referenced to Session 3 (red is for the maximum amplitude of 14 μV and dark blue for the minimum amplitude of 1 μV). It can be noted that when she came in, her brain was hypo-active, except for the right frontal region. His brain became less active in the frontal-right region but a little more active overall at the second visit (Session 2), after wearing the X39™ patch for 3 weeks. His brain shows more activity overall after wearing the X39™ patch for 6 weeks (Session 3).

Non-Invasive Scanning and Subtle Energy Testing Lab

Coherence

P300 Eyes Closed Z Scores

Band Ranges
 Theta: 4.5–7.5 Hz
 Alpha: 8.0–13.0 Hz
 Beta: 13.5–20.0 Hz

Color Key



THETA

ALPHA

BETA

Session 1

Z-Scores above 2.0 and below -2.0

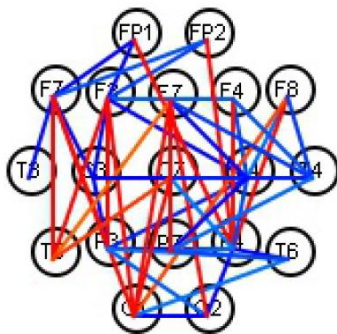

-COHERENCE-

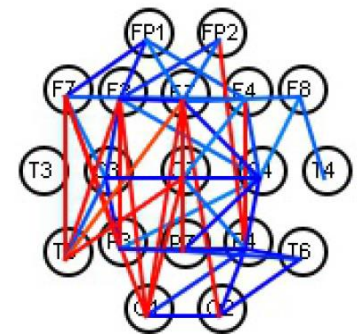
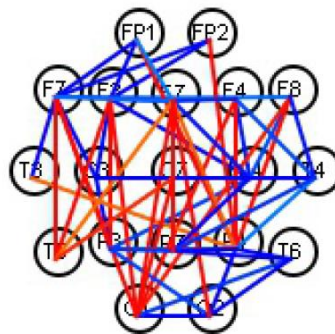

Session 2

Z-Scores above 2.0 and below -2.0

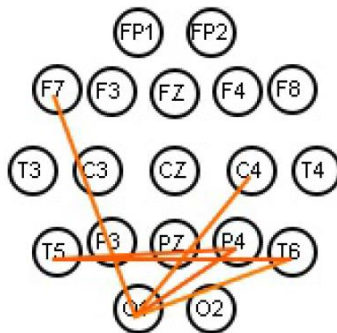

-COHERENCE-

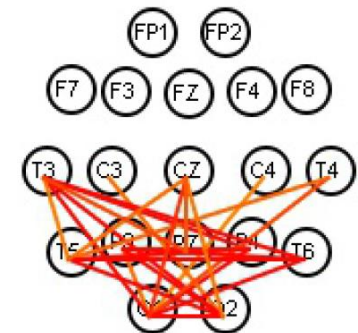
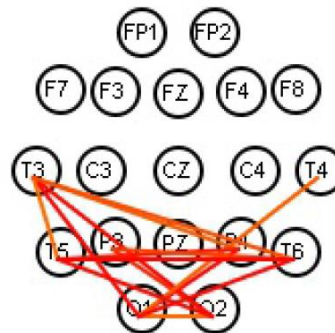

Session 3

Z-Scores above 2.0 and below -2.0

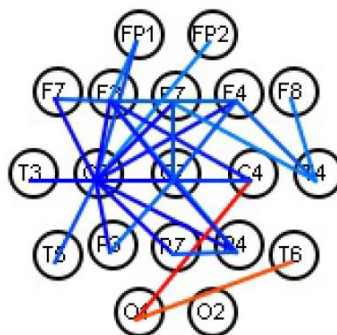

-COHERENCE-

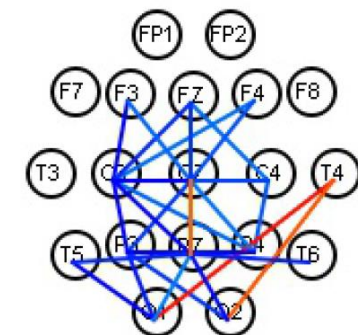
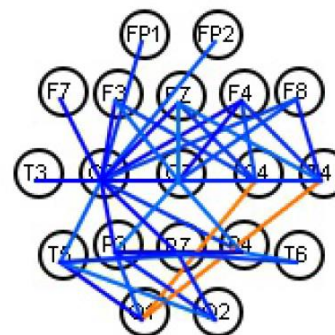



Non-Invasive Scanning and Subtle Energy Testing Lab

EEG coherence can be defined as the normalized cross-power spectrum per frequency of two signals recorded simultaneously at different sites of the scalp. It is a measure of the synchronization between the two signals and may be interpreted as an expression of their functional interaction (1). Coherence reflects how stable the phase relationship is between two electrode sites. Coherence quantifies the degree of interaction or communication, shared information, between brain sites. Hypercoherence is when brain sites are not functioning in efficient interdependent fashion, they have too much “cross-talk”, they are overly connected or locked together. Hypocoherence is called poor inter-site interaction and is associated with diminished cognitive efficiency (2). The red lines between two sites indicate hypercoherence while blue lines reflect hypocoherence. Beta brain waves are normally dominant in a person awake, alert, with normal level of consciousness and brain function. Alpha become dominant in a person with eyes closed, calm, aware and quietly alert. Theta brain waves show up in deep relaxation, meditation and mental imagery (3). Participants were awake with eyes closed during these measurements and so the most relevant results are those presented in the Alpha (relaxation) and Beta (normal brain activity) bands.

At the beginning of his participation (Session 1), Participant 4 had a mix of hypercoherence and hypocoherence at all 3 frequency bands (Beta, Alpha and Theta). After wearing the X39™ patch for 3 weeks (Session 2), there was some level of hypercoherence mainly in the occipital (back) region of the head for all frequency bands. After wearing the X39™ patch for 6 weeks (Session 3) there was almost no hypercoherence and as similar level of hypocoherence as observed at the beginning of his participation.

Screening Scores

Screening Scores	Session 1	Session 2	Session 3	Target Range
Performance Assessments				
Physical Reaction Time	304 (±43) ms	337 (±93) ms	291 (±38) ms	277–398 ms
Trail Making Test A	100 sec	81 sec	75 sec	76–130 sec
Trail Making Test B	113 sec	111 sec	92 sec	73–141 sec
Evoked Potentials				
Audio P300 Delay	452 ms	288 ms	260 ms	304–395 ms
Test/Retest Change	-	-164 ms	-192 ms	±11 ms
Audio P300 Voltage	13.6 µV	6.1 µV	14.0 µV	6–14 µV
Test/Retest Change	-	-7 µV	0 µV	±2 µV
State				
CZ Eyes Closed Theta/Beta (Power)	4.9	1.2	2.3	0.6–1.5
F3/F4 Eyes Closed Alpha (Magnitude)	1.7	1.1	1.3	0.9–1.1

Symbol Key: ◻ = Possible Artifact, ▽ = Sync Blinks

The goal is for each screening score to be inside the target range. If a score is below or above the target range it is considered abnormal (too fast if below or too slow if above the



Non-Invasive Scanning and Subtle Energy Testing Lab

target time). An explanation of each of screening score follows. These explanations are provided by p3baseline (www.p3baseline.com).

Physical Reaction time

It is a measure of speed in response to an audible odd tone. This relies on different pathways than the Auditory P300, so physical reaction time may be different than the brain speed.

Trail Making

A standard measure of brain function and includes measures of psychomotor and visual scanning.

Evoked Potentials - Auditory P300

Auditory P300 is a measure of brain response speed and attentional resources. P300 slowing and/or a reduction in voltage may signal changes in cognitive function.

State - CZ Theta/Beta

Theta and Beta frequency bands are affected by cortical arousal and can give insight into how the brain functions. In some people high Theta/Beta ratios at CZ may present as inattention, while others may benefit from cortical arousal.

Researchers have shown that calculating the relative power ratio Theta/Beta at CZ can be used to determine slow-wave disorders, ADHD, interpersonal detachment with qualitative aspects of autistic or Asperger's behavior (3, 4, 5).

State - F3/F4 Alpha

Large differences in Alpha power between the left-front and right-front of the brain have been associated with depression and/or anxiety.

Researchers also discovered that calculating F3/F4 relative power ratio in the Alpha band means processing information in a positive way for an increase while a decrease in the ratio indicated a more negative processing mode (6, 7).

Participant 5

Female, 63, Pranic healer. She indicated that she has a history of thyroid problems that she is treating with natural remedies. She experiences shortness of breath with heavy activity. She had a small skin cyst removed in August. For the entire duration of her participation she

Non-Invasive Scanning and Subtle Energy Testing Lab

placed the patch in the middle of the neck. At her first visit she indicated that her sense of well-being was 74% on the AIO-VAS (0 = worst you have ever been; 100% = best you have ever been) and her mood was +7 according to the BMIS (the BMIS scale goes from -10 = very unpleasant to +10 = very pleasant). At her second visit, her AIO-VAS score stayed at 74% and the BMIS score also stayed at +7. At her third visit her AIO-VAS score increased to 93% and her BMIS score increased to +9. The Overall Wellness Assessment form indicated that she felt as usual at the beginning of her participation and a lot better after 3 weeks and 6 weeks into her participation.

Scalp Topography Map

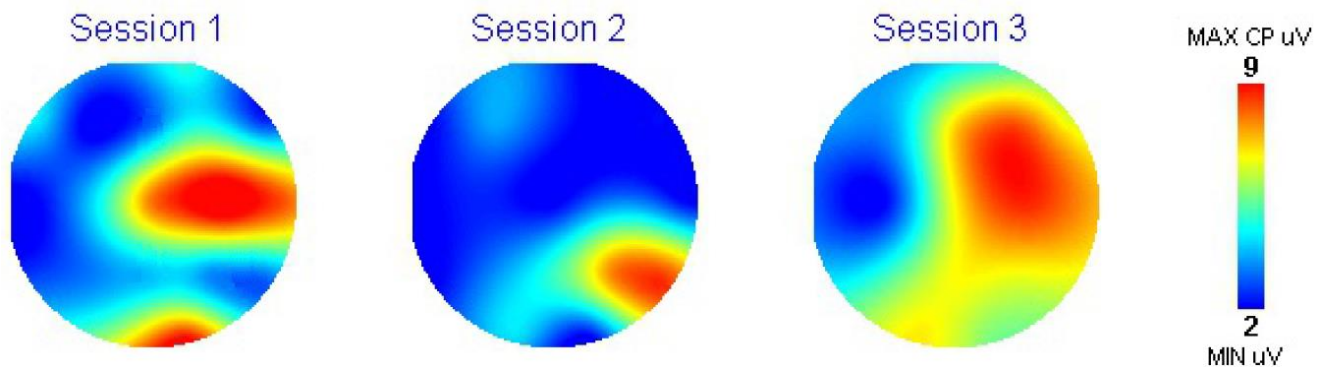

These scalp topographical maps were computed from the 19 EEG channels recorded by the brain mapping system. These maps show the amplitude of the P300 recording for each channel (in microvolts or μV) using a color-coding scale presented on the right side referenced to Session 3 (red is for the maximum amplitude of 9 μV and dark blue for the minimum amplitude of 2 μV). It can be noted that when she came in, her brain shows high activity in the right hemisphere and low activity in the left hemisphere. Her brain calmed down dramatically at the second visit (Session 2), 3 weeks after wearing the X39™ patch for 3 weeks. After wearing the X39™ patch for 6 weeks, her brain more active (Session 3).

Non-Invasive Scanning and Subtle Energy Testing Lab

Coherence

P300 Eyes Closed Z Scores

Band Ranges
 Theta: 4.5–7.5 Hz
 Alpha: 8.0–13.0 Hz
 Beta: 13.5–20.0 Hz

Color Key



THETA

ALPHA

BETA

Session 1

Z-Scores above 2.0 and below -2.0

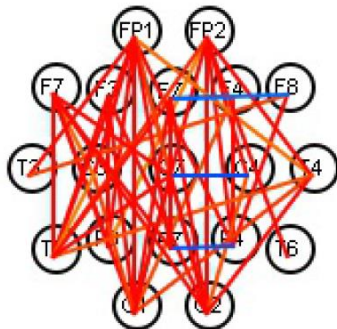

-COHERENCE-

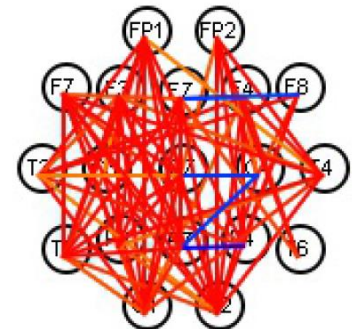
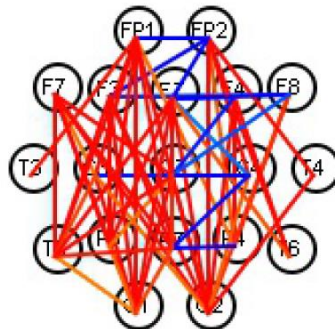

Session 2

Z-Scores above 2.0 and below -2.0

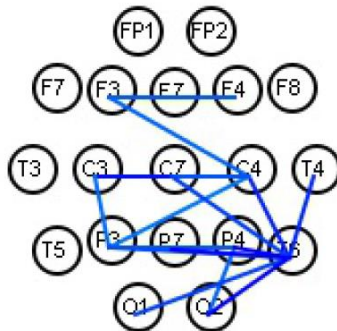

-COHERENCE-

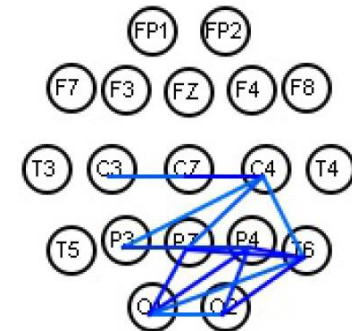
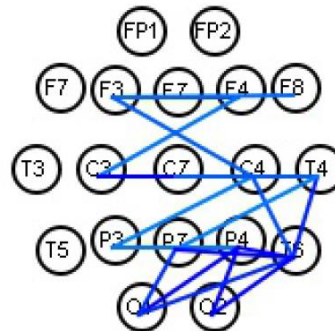

Session 3

Z-Scores above 2.0 and below -2.0

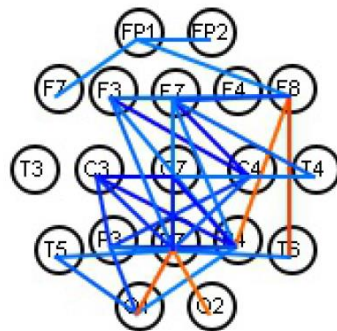

-COHERENCE-

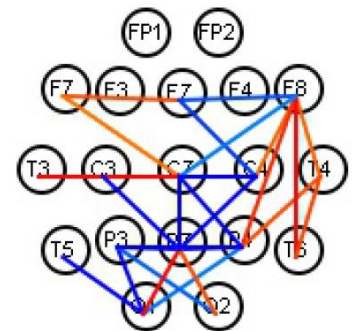
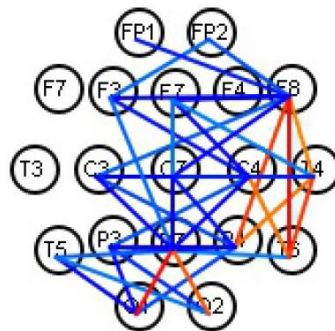



Non-Invasive Scanning and Subtle Energy Testing Lab

EEG coherence can be defined as the normalized cross-power spectrum per frequency of two signals recorded simultaneously at different sites of the scalp. It is a measure of the synchronization between the two signals and may be interpreted as an expression of their functional interaction (1). Coherence reflects how stable the phase relationship is between two electrode sites. Coherence quantifies the degree of interaction or communication, shared information, between brain sites. Hypercoherence is when brain sites are not functioning in efficient interdependent fashion, they have too much “cross-talk”, they are overly connected or locked together. Hypocoherence is called poor inter-site interaction and is associated with diminished cognitive efficiency (2). The red lines between two sites indicate hypercoherence while blue lines reflect hypocoherence. Beta brain waves are normally dominant in a person awake, alert, with normal level of consciousness and brain function. Alpha become dominant in a person with eyes closed, calm, aware and quietly alert. Theta brain waves show up in deep relaxation, meditation and mental imagery (3). Participants were awake with eyes closed during these measurements and so the most relevant results are those presented in the Alpha (relaxation) and Beta (normal brain activity) bands.

At the beginning of her participation (Session 1), Participant 5 had most of her brain sites in hypercoherence for all 3 frequency bands (Beta, Alpha and Theta). After wearing the X39™ patch for 3 weeks (Session 2), there was only a few lines of hypocoherence, mainly in the occipital (back) region of her brain at all brain frequencies. After wearing the X39™ patch for 6 weeks (Session 3) there was a bit more hypercoherence than at 3 weeks mainly on the right side of the brain with some hypocoherence mainly in the middle of the brain (more so at Alpha and Theta).

Screening Scores

Screening Scores	Session 1	Session 2	Session 3	Target Range
Performance Assessments				
Physical Reaction Time	403 (±47) ms	441 (±123) ms	408 (±82) ms	263–378 ms
Trail Making Test A	68 sec	84 sec	114 sec	61–104 sec
Trail Making Test B	145 sec	209 sec	151 sec	59–114 sec
Evoked Potentials				
Audio P300 Delay	▣ 284 ms	328 ms	368 ms	287–373 ms
Test/Retest Change	-	44 ms	84 ms	±11 ms
Audio P300 Voltage	▣ 11.1 µV	7.4 µV	7.3 µV	6–16 µV
Test/Retest Change	-	-4 µV	-4 µV	±2 µV
State				
CZ Eyes Closed Theta/Beta (Power)	◆ 1.7	▣ 0.7	0.5	0.7–1.6
F3/F4 Eyes Closed Alpha (Magnitude)	◆ 1.1	1.1	0.4	0.9–1.1

Symbol Key: ▣ = Possible Artifact, ▽ = Sync Blinks

The goal is for each screening score to be inside the target range. If a score is below or above the target range it is considered abnormal (too fast if below or too slow if above the



Non-Invasive Scanning and Subtle Energy Testing Lab

target time). An explanation of each of screening score follows. These explanations are provided by p3baseline (www.p3baseline.com).

Physical Reaction time

It is a measure of speed in response to an audible odd tone. This relies on different pathways than the Auditory P300, so physical reaction time may be different than the brain speed.

Trail Making

A standard measure of brain function and includes measures of psychomotor and visual scanning.

Evoked Potentials - Auditory P300

Auditory P300 is a measure of brain response speed and attentional resources. P300 slowing and/or a reduction in voltage may signal changes in cognitive function.

State - CZ Theta/Beta

Theta and Beta frequency bands are affected by cortical arousal and can give insight into how the brain functions. In some people high Theta/Beta ratios at CZ may present as inattention, while others may benefit from cortical arousal.

Researchers have shown that calculating the relative power ratio Theta/Beta at CZ can be used to determine slow-wave disorders, ADHD, interpersonal detachment with qualitative aspects of autistic or Asperger's behavior (3, 4, 5).

State - F3/F4 Alpha

Large differences in Alpha power between the left-front and right-front of the brain have been associated with depression and/or anxiety.

Researchers also discovered that calculating F3/F4 relative power ratio in the Alpha band means processing information in a positive way for an increase while a decrease in the ratio indicated a more negative processing mode (6, 7).

Participant 6

Female, 58, tile setter. She indicated that she has trigger finger on middle finger of the left hand. For the entire duration of her participation she placed the patch three inches below the navel. At her first visit she indicated that her sense of well-being was 88% on the AIO-VAS (0 = worst you have ever been; 100% = best you have ever been) and her mood was +8

Non-Invasive Scanning and Subtle Energy Testing Lab

according to the BMIS (the BMIS scale goes from -10 = very unpleasant to +10 = very pleasant). At her second visit, her AIO-VAS score decreased to 22% and the BMIS score became -4 (she indicated that she went through an emotional upset). At her third visit her AIO-VAS score increased to 53% and her BMIS score increased to +8. The Overall Wellness Assessment form indicated that her feeling was as usual for the entire time of participation.

Scalp Topography Map

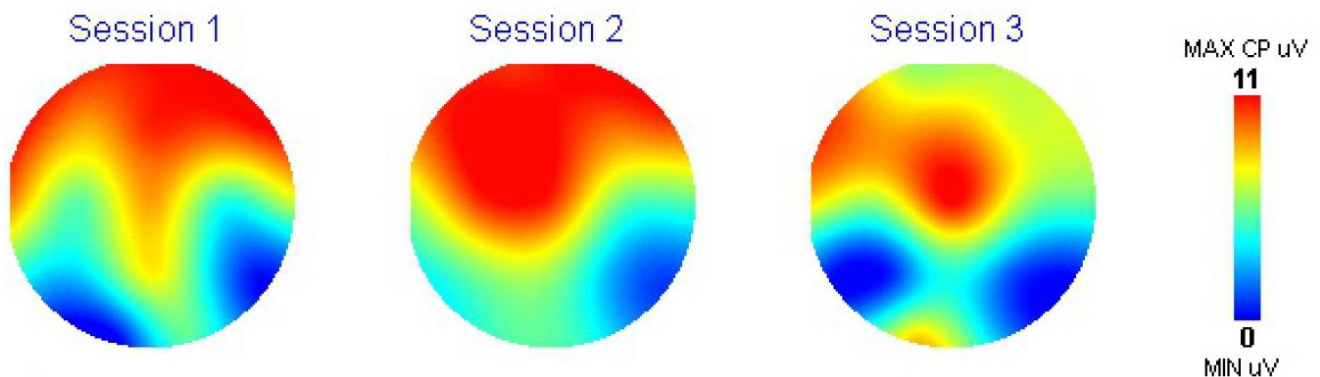

These scalp topographical maps were computed from the 19 EEG channels recorded by the brain mapping system. These maps show the amplitude of the P300 recording for each channel (in microvolts or μV) using a color-coding scale presented on the right side referenced to Session 3 (red is for the maximum amplitude of 11 μV and dark blue for the minimum amplitude of 0 μV). It can be noted that when he came in, his brain was hyperactive in the frontal lobes. His brain remained active at the second visit (Session 2), after wearing the X39™ patch for 3 weeks. However, his brain calmed down significantly after 6 weeks (Session 3).

Non-Invasive Scanning and Subtle Energy Testing Lab

Coherence

P300 Eyes Closed Z Scores

Band Ranges
 Theta: 4.5–7.5 Hz
 Alpha: 8.0–13.0 Hz
 Beta: 13.5–20.0 Hz

Color Key



THETA

ALPHA

BETA

Session 1

Z-Scores above 2.0 and below -2.0

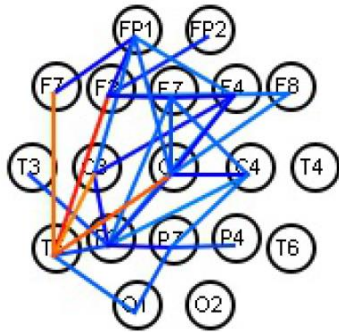

-COHERENCE-

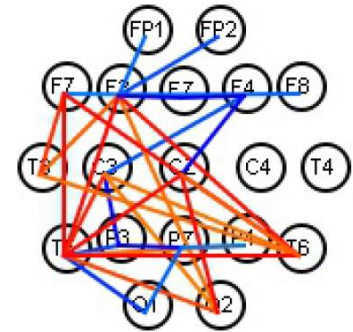
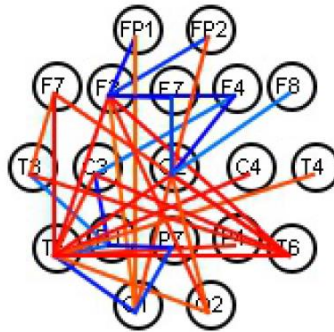

Session 2

Z-Scores above 2.0 and below -2.0

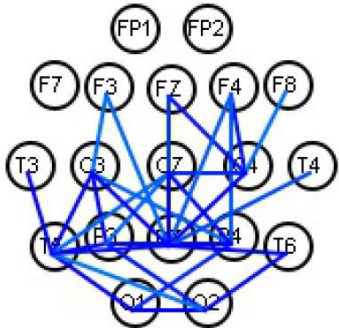

-COHERENCE-

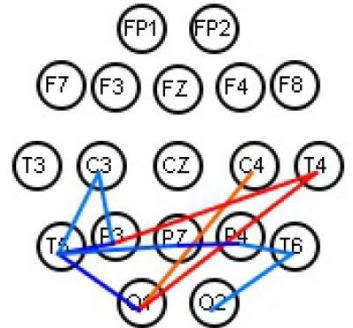
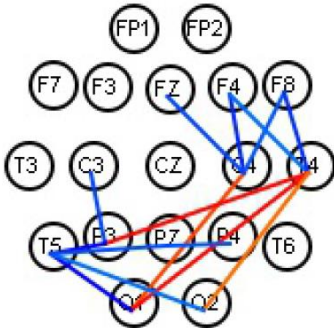

Session 3

Z-Scores above 2.0 and below -2.0

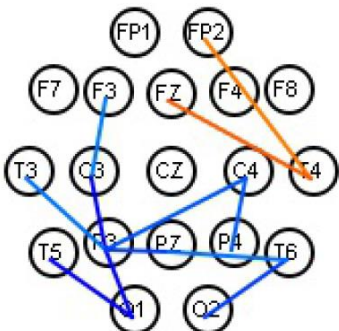

-COHERENCE-

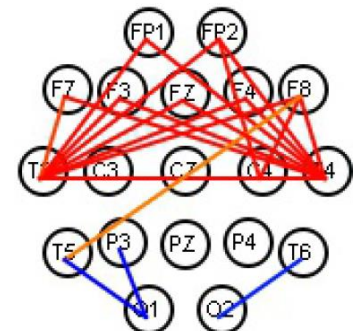
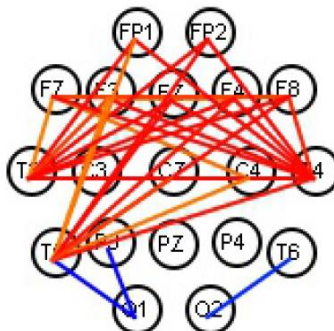



Non-Invasive Scanning and Subtle Energy Testing Lab

EEG coherence can be defined as the normalized cross-power spectrum per frequency of two signals recorded simultaneously at different sites of the scalp. It is a measure of the synchronization between the two signals and may be interpreted as an expression of their functional interaction (1). Coherence reflects how stable the phase relationship is between two electrode sites. Coherence quantifies the degree of interaction or communication, shared information, between brain sites. Hypercoherence is when brain sites are not functioning in efficient interdependent fashion, they have too much “cross-talk”, they are overly connected or locked together. Hypocoherence is called poor inter-site interaction and is associated with diminished cognitive efficiency (2). The red lines between two sites indicate hypercoherence while blue lines reflect hypocoherence. Beta brain waves are normally dominant in a person awake, alert, with normal level of consciousness and brain function. Alpha become dominant in a person with eyes closed, calm, aware and quietly alert. Theta brain waves show up in deep relaxation, meditation and mental imagery (3). Participants were awake with eyes closed during these measurements and so the most relevant results are those presented in the Alpha (relaxation) and Beta (normal brain activity) bands.

At the beginning of her participation (Session 1), Participant 6 had a mix of hypercoherence (mainly Beta and Alpha) and hypocoherence (Theta). After wearing the X39™ patch for 3 weeks (Session 2), most of the hypercoherence disappeared (except for a little bit in the back of the brain at Alpha and Beta frequency bands) mainly in the occipital (back) region of the head for all frequency bands. After wearing the X39™ patch for 6 weeks (Session 3) hypercoherence reappeared in the frontal region of the brain, mainly in Beta and Alpha frequency bands.

Screening Scores

Screening Scores	Session 1	Session 2	Session 3	Target Range
Performance Assessments				
Physical Reaction Time	260 (±37) ms	293 (±48) ms	271 (±73) ms	257–370 ms
Trail Making Test A	65 sec	37 sec	60 sec	54–93 sec
Trail Making Test B	82 sec	102 sec	126 sec	53–103 sec
Evoked Potentials				
Audio P300 Delay	■ 264 ms	276 ms	272 ms	278–361 ms
Test/Retest Change	-	12 ms	8 ms	±11 ms
Audio P300 Voltage	■▽ 15.9 µV	12.2 µV	11.1 µV	7–17 µV
Test/Retest Change	-	-4 µV	-5 µV	±2 µV
State				
CZ Eyes Closed Theta/Beta (Power)	1.2	1.8	1.5	0.7–1.7
F3/F4 Eyes Closed Alpha (Magnitude)	0.6	1.2	1.0	0.9–1.1

Symbol Key: ■ = Possible Artifact, ▽ = Sync Blinks

The goal is for each screening score to be inside the target range. If a score is below or above the target range it is considered abnormal (too fast if below or too slow if above the



Non-Invasive Scanning and Subtle Energy Testing Lab

target time). An explanation of each of screening score follows. These explanations are provided by p3baseline (www.p3baseline.com).

Physical Reaction time

It is a measure of speed in response to an audible odd tone. This relies on different pathways than the Auditory P300, so physical reaction time may be different than the brain speed.

Trail Making

A standard measure of brain function and includes measures of psychomotor and visual scanning.

Evoked Potentials - Auditory P300

Auditory P300 is a measure of brain response speed and attentional resources. P300 slowing and/or a reduction in voltage may signal changes in cognitive function.

State - CZ Theta/Beta

Theta and Beta frequency bands are affected by cortical arousal and can give insight into how the brain functions. In some people high Theta/Beta ratios at CZ may present as inattention, while others may benefit from cortical arousal.

Researchers have shown that calculating the relative power ratio Theta/Beta at CZ can be used to determine slow-wave disorders, ADHD, interpersonal detachment with qualitative aspects of autistic or Asperger's behavior (3, 4, 5).

State - F3/F4 Alpha

Large differences in Alpha power between the left-front and right-front of the brain have been associated with depression and/or anxiety.

Researchers also discovered that calculating F3/F4 relative power ratio in the Alpha band means processing information in a positive way for an increase while a decrease in the ratio indicated a more negative processing mode (6, 7).

Participant 7

Female, 66, sales associate. She indicated that she has high blood pressure but she takes no medication. For the entire duration of her participation she placed the patch three inches below the navel. At her first visit she indicated that her sense of well-being was 66% on the AIO-VAS (0 = worst you have ever been; 100% = best you have ever been) and her mood

Non-Invasive Scanning and Subtle Energy Testing Lab

was +8 according to the BMIS (the BMIS scale goes from -10 = very unpleasant to +10 = very pleasant). At her second visit, her AIO-VAS score increased to 83% and the BMIS score became +10. At her third visit her AIO-VAS score was about the same 82% and her BMIS score stayed at +10. She wrote that she felt more energetic at the end of her participation. The Overall Wellness Assessment form indicated that her feeling was a lot better at her first visit, became slightly better than usual at her second visit and became again a lot better than usual at her third and final visit.

Scalp Topography Map

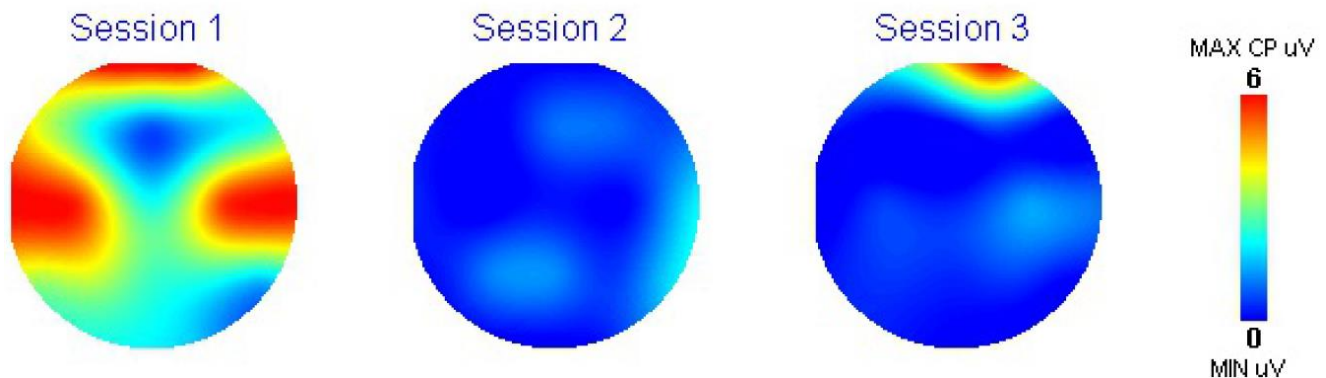

These scalp topographical maps were computed from the 19 EEG channels recorded by the brain mapping system. These maps show the amplitude of the P300 recording for each channel (in microvolts or μV) using a color-coding scale presented on the right side referenced to Session 3 (red is for the maximum amplitude of 6 μV and dark blue for the minimum amplitude of 0 μV). It can be noted that when she came in, her brain was hyperactive. Her brain calmed down dramatically at the second visit (Session 2), after wearing the X39™ patch for 3 weeks. Her brain remained calm after wearing the X39™ patch for 6 weeks (Session 3).

Non-Invasive Scanning and Subtle Energy Testing Lab

Coherence

P300 Eyes Closed Z Scores

Band Ranges
 Theta: 4.5–7.5 Hz
 Alpha: 8.0–13.0 Hz
 Beta: 13.5–20.0 Hz

Color Key



THETA

ALPHA

BETA

Session 1

Z-Scores above 2.0 and below -2.0

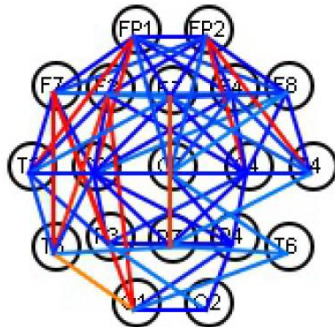

-COHERENCE-

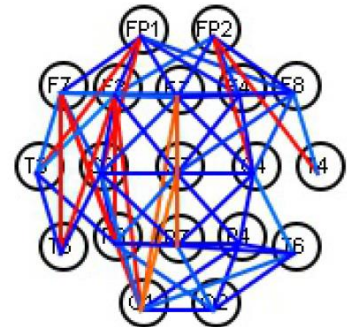
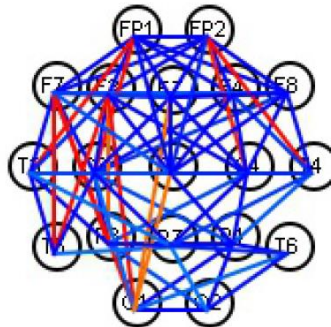

Session 2

Z-Scores above 2.0 and below -2.0

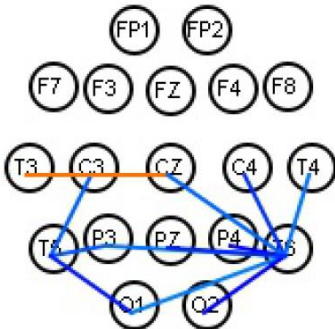

-COHERENCE-

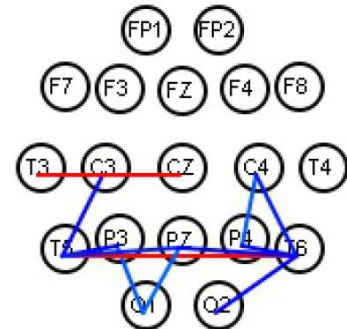
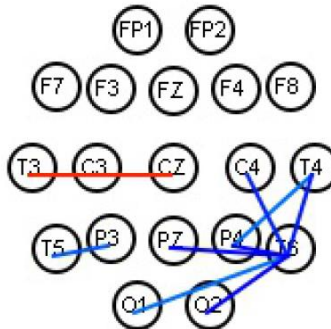

Session 3

Z-Scores above 2.0 and below -2.0

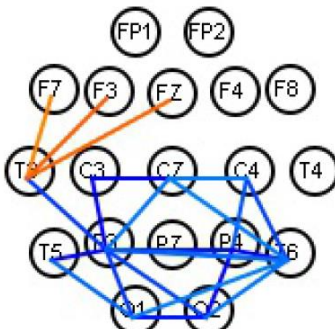

-COHERENCE-

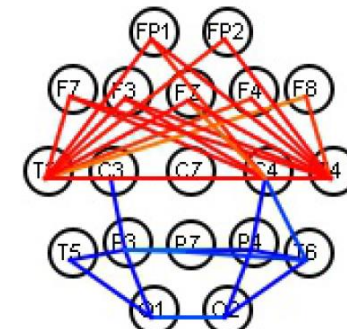
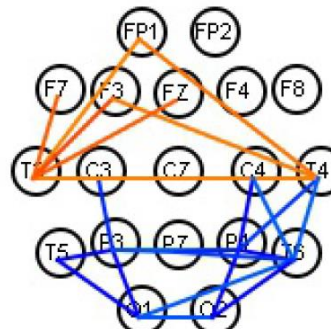



Non-Invasive Scanning and Subtle Energy Testing Lab

EEG coherence can be defined as the normalized cross-power spectrum per frequency of two signals recorded simultaneously at different sites of the scalp. It is a measure of the synchronization between the two signals and may be interpreted as an expression of their functional interaction (1). Coherence reflects how stable the phase relationship is between two electrode sites. Coherence quantifies the degree of interaction or communication, shared information, between brain sites. Hypercoherence is when brain sites are not functioning in efficient interdependent fashion, they have too much “cross-talk”, they are overly connected or locked together. Hypocoherence is called poor inter-site interaction and is associated with diminished cognitive efficiency (2). The red lines between two sites indicate hypercoherence while blue lines reflect hypocoherence. Beta brain waves are normally dominant in a person awake, alert, with normal level of consciousness and brain function. Alpha become dominant in a person with eyes closed, calm, aware and quietly alert. Theta brain waves show up in deep relaxation, meditation and mental imagery (3). Participants were awake with eyes closed during these measurements and so the most relevant results are those presented in the Alpha (relaxation) and Beta (normal brain activity) bands.

At the beginning of her participation (Session 1), Participant 7 had a mix of hypercoherence and hypocoherence at all 3 frequency bands (Beta, Alpha and Theta). After wearing the X39™ patch for 3 weeks (Session 2), there was almost no hypercoherence and some hypocoherence mainly in the occipital (back) region of the head for all frequency bands. After wearing the X39™ patch for 6 weeks (Session 3) there was hypercoherence mainly in the frontal part of the brain and mainly in the Beta frequency band.

Screening Scores

Screening Scores	Session 1	Session 2	Session 3	Target Range
Performance Assessments				
Physical Reaction Time	317 (±37) ms	343 (±50) ms	294 (±48) ms	265–382 ms
Trail Making Test A	63 sec	63 sec	99 sec	64–109 sec
Trail Making Test B	124 sec	98 sec	257 sec	62–119 sec
Evoked Potentials				
Audio P300 Delay	344 ms	N/A	N/A	291–378 ms
Test/Retest Change	-	N/A	N/A	±11 ms
Audio P300 Voltage	12.7 µV	2.1 µV	1.8 µV	6–15 µV
Test/Retest Change	-	-11 µV	-11 µV	±2 µV
State				
CZ Eyes Closed Theta/Beta (Power)	1.0	1.1	1.5	0.7–1.6
F3/F4 Eyes Closed Alpha (Magnitude)	4.3	1.1	0.7	0.9–1.1

Symbol Key: ■ = Possible Artifact, ▽ = Sync Blinks

The goal is for each screening score to be inside the target range. If a score is below or above the target range it is considered abnormal (too fast if below or too slow if above the target time). An explanation of each of screening score follows. These explanations are provided by p3baseline (www.p3baseline.com).



Non-Invasive Scanning and Subtle Energy Testing Lab

Physical Reaction time

It is a measure of speed in response to an audible odd tone. This relies on different pathways than the Auditory P300, so physical reaction time may be different than the brain speed.

Trail Making

A standard measure of brain function and includes measures of psychomotor and visual scanning.

Evoked Potentials - Auditory P300

Auditory P300 is a measure of brain response speed and attentional resources. P300 slowing and/or a reduction in voltage may signal changes in cognitive function.

State - CZ Theta/Beta

Theta and Beta frequency bands are affected by cortical arousal and can give insight into how the brain functions. In some people high Theta/Beta ratios at CZ may present as inattention, while others may benefit from cortical arousal.

Researchers have shown that calculating the relative power ratio Theta/Beta at CZ can be used to determine slow-wave disorders, ADHD, interpersonal detachment with qualitative aspects of autistic or Asperger's behavior (3, 4, 5).

State - F3/F4 Alpha

Large differences in Alpha power between the left-front and right-front of the brain have been associated with depression and/or anxiety.

Researchers also discovered that calculating F3/F4 relative power ratio in the Alpha band means processing information in a positive way for an increase while a decrease in the ratio indicated a more negative processing mode (6, 7).

Participant 8

Female, 70, Trade Joe's crew member. For the entire duration of her participation she placed the patch at the back of the neck. At her first visit she indicated that her sense of well-being was 100% on the AIO-VAS (0 = worst you have ever been; 100% = best you have ever been) and her mood was +10 according to the BMIS (the BMIS scale goes from -10 = very unpleasant to +10 = very pleasant). At her second visit, her AIO-VAS score decreased to 82% and the BMIS score stayed at +10. At her third visit her AIO-VAS score increased to

Non-Invasive Scanning and Subtle Energy Testing Lab

90% and her BMIS score stayed at +10. She wrote that she felt more energy and well-being and that she has great dreams and sleep. The Overall Wellness Assessment form indicated that her feeling was a lot better than usual at all three of her visits.

Scalp Topography Map

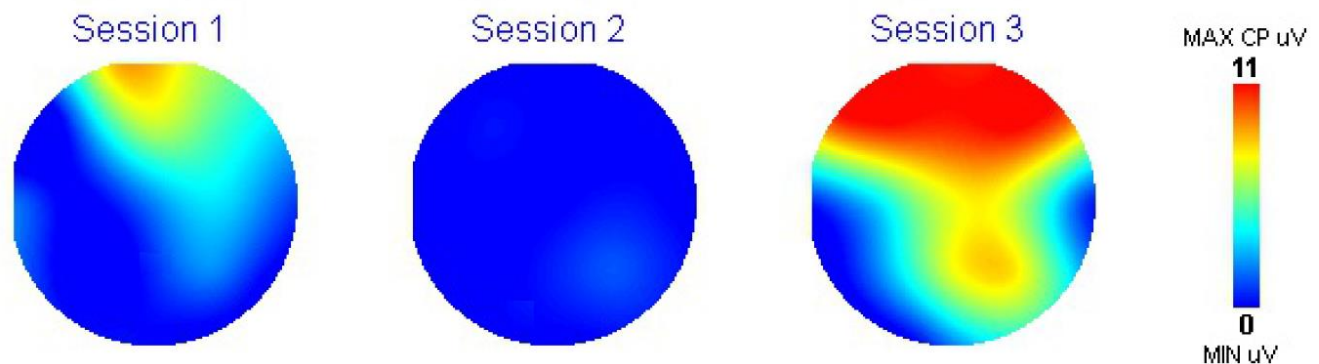

These scalp topographical maps were computed from the 19 EEG channels recorded by the brain mapping system. These maps show the amplitude of the P300 recording for each channel (in microvolts or μV) using a color-coding scale presented on the right side referenced to Session 3 (red is for the maximum amplitude of 11 μV and dark blue for the minimum amplitude of 0 μV). It can be noted that when she came in, her brain was active mainly in the frontal lobes. Her brain shows very low activity at the second visit (Session 2), after wearing the X39™ patch for 3 weeks. However, her brain became very active after wearing the X39™ patch for 6 weeks (Session 3).

Non-Invasive Scanning and Subtle Energy Testing Lab

Coherence

P300 Eyes Closed Z Scores

Band Ranges
 Theta: 4.5–7.5 Hz
 Alpha: 8.0–13.0 Hz
 Beta: 13.5–20.0 Hz

Color Key



THETA

ALPHA

BETA

Session 1

Z-Scores above 2.0 and below -2.0

-COHERENCE-

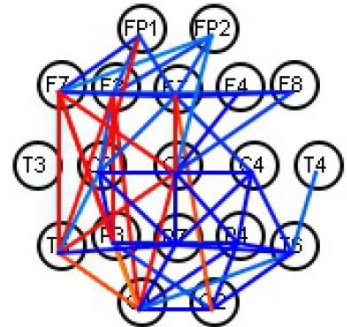
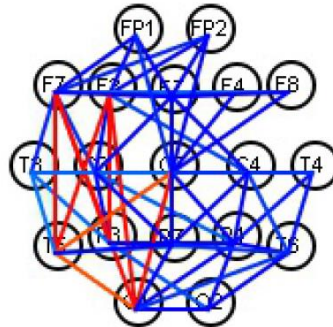
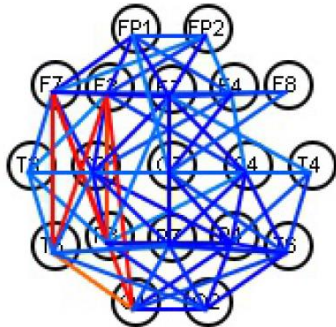

Session 2

Z-Scores above 2.0 and below -2.0

-COHERENCE-

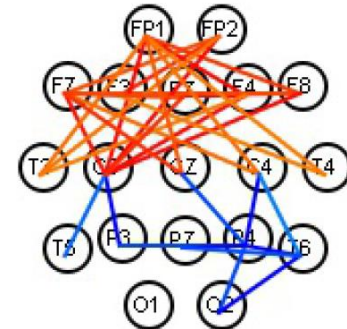
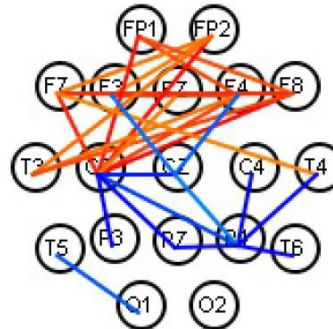
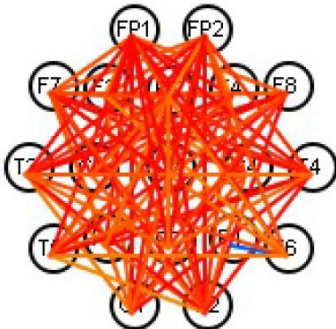

Session 3

Z-Scores above 2.0 and below -2.0

-COHERENCE-

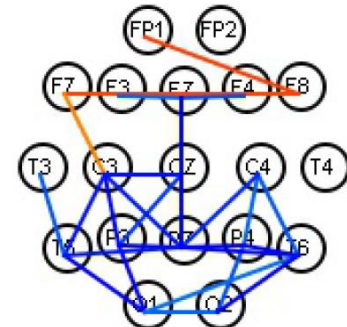
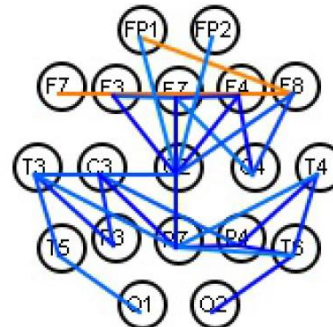
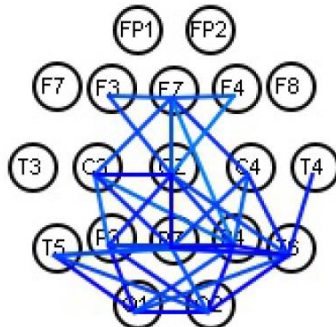



Non-Invasive Scanning and Subtle Energy Testing Lab

EEG coherence can be defined as the normalized cross-power spectrum per frequency of two signals recorded simultaneously at different sites of the scalp. It is a measure of the synchronization between the two signals and may be interpreted as an expression of their functional interaction (1). Coherence reflects how stable the phase relationship is between two electrode sites. Coherence quantifies the degree of interaction or communication, shared information, between brain sites. Hypercoherence is when brain sites are not functioning in efficient interdependent fashion, they have too much “cross-talk”, they are overly connected or locked together. Hypocoherence is called poor inter-site interaction and is associated with diminished cognitive efficiency (2). The red lines between two sites indicate hypercoherence while blue lines reflect hypocoherence. Beta brain waves are normally dominant in a person awake, alert, with normal level of consciousness and brain function. Alpha become dominant in a person with eyes closed, calm, aware and quietly alert. Theta brain waves show up in deep relaxation, meditation and mental imagery (3). Participants were awake with eyes closed during these measurements and so the most relevant results are those presented in the Alpha (relaxation) and Beta (normal brain activity) bands.

At the beginning of her participation (Session 1), Participant 8 had a mix of hypercoherence and hypocoherence at all 3 frequency bands (Beta, Alpha and Theta). After wearing the X39™ patch for 3 weeks (Session 2), there was an excess in hypercoherence in the Theta frequency band and some hypocoherence mainly in the frontal region of the head for Beta

and Alpha frequency bands. After wearing the X39™ patch for 6 weeks (Session 3) there was almost no hypercoherence (mainly in the frontal part of the brain and mainly in the Beta and Alpha frequency bands) and hypocoherence in the occipital (back) of the head at all 3 frequency bands.

Screening Scores

Screening Scores	Session 1	Session 2	Session 3	Target Range
Performance Assessments				
Physical Reaction Time	386 (±49) ms	405 (±59) ms	355 (±47) ms	273–393 ms
Trail Making Test A	83 sec	69 sec	64 sec	73–123 sec
Trail Making Test B	156 sec	88 sec	108 sec	69–135 sec
Evoked Potentials				
Audio P300 Delay	360 ms	N/A	▣ 360 ms	300–390 ms
Test/Retest Change	-	N/A	0 ms	±11 ms
Audio P300 Voltage	5.4 μV	2.3 μV	▣ 11.1 μV	6–15 μV
Test/Retest Change	-	-3 μV	6 μV	±2 μV
State				
CZ Eyes Closed Theta/Beta (Power)	▣ 1.0	3.5	1.3	0.6–1.5
F3/F4 Eyes Closed Alpha (Magnitude)	1.8	1.1	2.1	0.9–1.1

Symbol Key: ▣ = Possible Artifact, ▽ = Sync Blinks



Non-Invasive Scanning and Subtle Energy Testing Lab

The goal is for each screening score to be inside the target range. If a score is below or above the target range it is considered abnormal (too fast if below or too slow if above the target time). An explanation of each of screening score follows. These explanations are provided by p3baseline (www.p3baseline.com).

Physical Reaction time

It is a measure of speed in response to an audible odd tone. This relies on different pathways than the Auditory P300, so physical reaction time may be different than the brain speed.

Trail Making

A standard measure of brain function and includes measures of psychomotor and visual scanning.

Evoked Potentials - Auditory P300

Auditory P300 is a measure of brain response speed and attentional resources. P300 slowing and/or a reduction in voltage may signal changes in cognitive function

State - CZ Theta/Beta

Theta and Beta frequency bands are affected by cortical arousal and can give insight into how the brain functions. In some people high Theta/Beta ratios at CZ may present as inattention, while others may benefit from cortical arousal.

Researchers have shown that calculating the relative power ratio Theta/Beta at CZ can be used to determine slow-wave disorders, ADHD, interpersonal detachment with qualitative aspects of autistic or Asperger's behavior (3, 4, 5).

State - F3/F4 Alpha

Large differences in Alpha power between the left-front and right-front of the brain have been associated with depression and/or anxiety.

Researchers also discovered that calculating F3/F4 relative power ratio in the Alpha band means processing information in a positive way for an increase while a decrease in the ratio indicated a more negative processing mode (6, 7).

Non-Invasive Scanning and Subtle Energy Testing Lab

Participant 9

Male, 63, Realtor. He indicated that he experiences short of breath with mild exertion. For the entire duration of his participation he placed the patch three inches below the navel. At his first visit he indicated that his sense of well-being was 83% on the AIO-VAS (0 = worst you have ever been; 100% = best you have ever been) and his mood was +9 according to the BMIS (the BMIS scale goes from -10 = very unpleasant to +10 = very pleasant). At his second visit, her AIO-VAS score increased to 95% and the BMIS score became +8. At his third visit his AIO-VAS score decreased a bit to 92% and his BMIS score increased to +9. The Overall Wellness Assessment form indicated that his feeling was as usual for the entire time of participation.

Scalp Topography Map

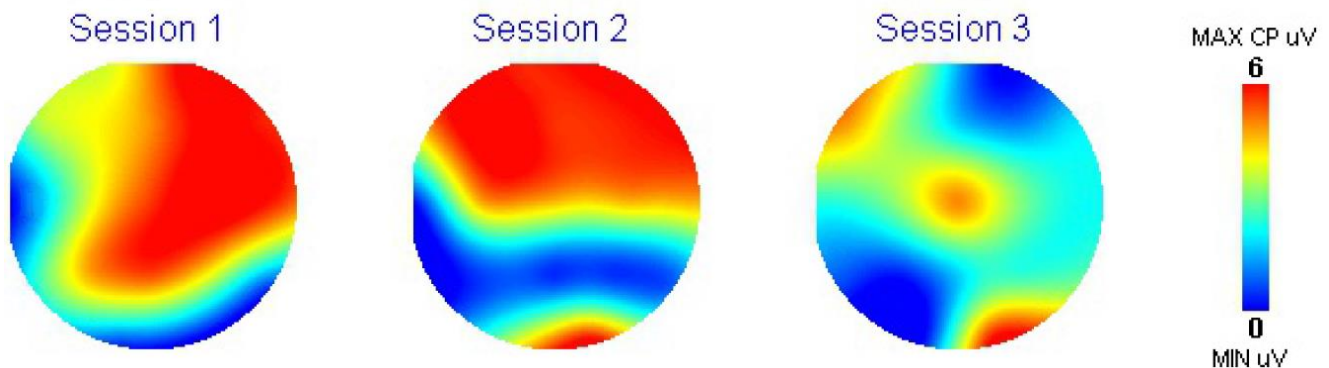

These scalp topographical maps were computed from the 19 EEG channels recorded by the brain mapping system. These maps show the amplitude of the P300 recording for each channel (in microvolts or μV) using a color-coding scale presented on the right side referenced to Session 3 (red is for the maximum amplitude of 6 μV and dark blue for the minimum amplitude of 0 μV). It can be noted that when he came in, his brain was hyperactive. His brain remained hyperactive at the second visit (Session 2), after wearing the X39™ patch for 3 weeks. However, his brain calmed down quite a bit to show normal activity after wearing the X39™ patch for 6 weeks (Session 3).

Non-Invasive Scanning and Subtle Energy Testing Lab

Coherence

P300 Eyes Closed Z Scores

Band Ranges
 Theta: 4.5–7.5 Hz
 Alpha: 8.0–13.0 Hz
 Beta: 13.5–20.0 Hz

Color Key



THETA

ALPHA

BETA

Session 1

Z-Scores above 2.0 and below -2.0

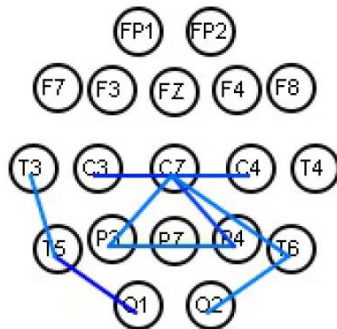

-COHERENCE-

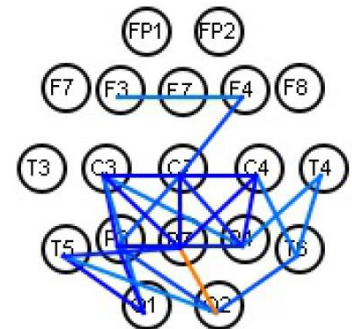
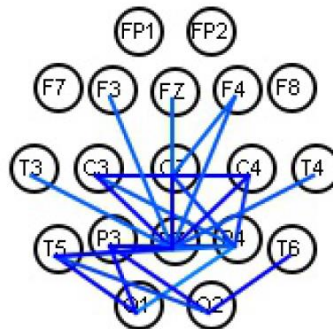

Session 2

Z-Scores above 2.0 and below -2.0

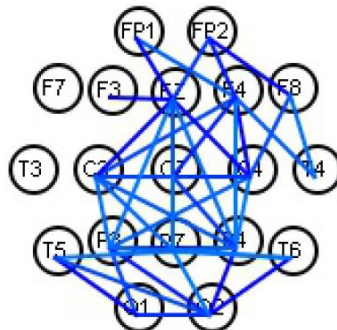

-COHERENCE-

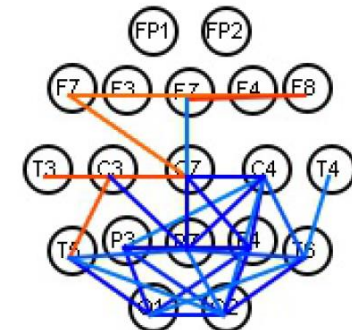
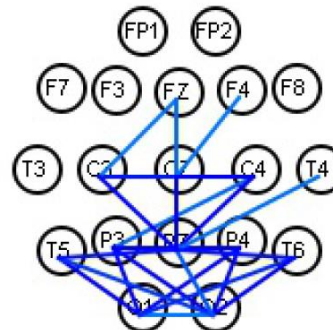

Session 3

Z-Scores above 2.0 and below -2.0

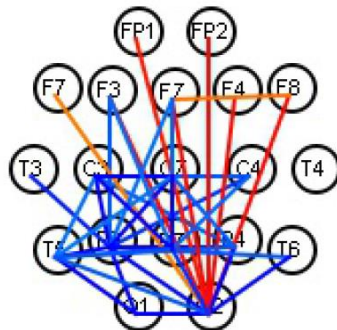

-COHERENCE-

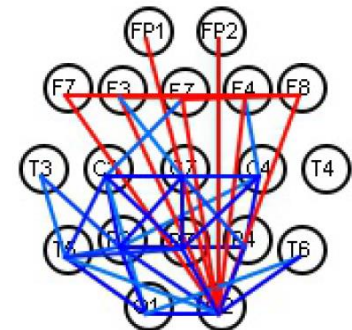
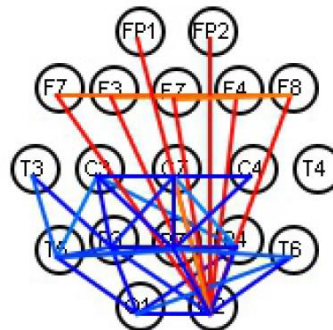



Non-Invasive Scanning and Subtle Energy Testing Lab

EEG coherence can be defined as the normalized cross-power spectrum per frequency of two signals recorded simultaneously at different sites of the scalp. It is a measure of the synchronization between the two signals and may be interpreted as an expression of their functional interaction (1). Coherence reflects how stable the phase relationship is between two electrode sites. Coherence quantifies the degree of interaction or communication, shared information, between brain sites. Hypercoherence is when brain sites are not functioning in efficient interdependent fashion, they have too much “cross-talk”, they are overly connected or locked together. Hypocoherence is called poor inter-site interaction and is associated with diminished cognitive efficiency (2). The red lines between two sites indicate hypercoherence while blue lines reflect hypocoherence. Beta brain waves are normally dominant in a person awake, alert, with normal level of consciousness and brain function. Alpha become dominant in a person with eyes closed, calm, aware and quietly alert. Theta brain waves show up in deep relaxation, meditation and mental imagery (3). Participants were awake with eyes closed during these measurements and so the most relevant results are those presented in the Alpha (relaxation) and Beta (normal brain activity) bands.

At the beginning of his participation (Session 1), Participant 9 had some level of hypocoherence in the occipital (back) of the head at all 3 frequency bands (Beta, Alpha and Theta). After wearing the X39™ patch for 3 weeks (Session 2), a few hypercoherence lines appeared in the frontal region of the brain with similar level of hypocoherence in the back of

the head at all frequency bands. After wearing the X39™ patch for 6 weeks (Session 3) there was an increase in hypercoherence mainly in the frontal part of the brain and all frequency bands and hypocoherence in the occipital (back) of the head at all 3 frequency bands.

Screening Scores

Screening Scores	Session 1	Session 2	Session 3	Target Range
Performance Assessments				
Physical Reaction Time	403 (±112) ms	458 (±130) ms	461 (±82) ms	263–378 ms
Trail Making Test A	69 sec	61 sec	110 sec	61–104 sec
Trail Making Test B	88 sec	106 sec	85 sec	59–114 sec
Evoked Potentials				
Audio P300 Delay	▣ 348 ms	288 ms	276 ms	287–373 ms
Test/Retest Change	-	-60 ms	-72 ms	±11 ms
Audio P300 Voltage	▣ 9.5 μV	5.3 μV	4.8 μV	6–16 μV
Test/Retest Change	-	-4 μV	-5 μV	±2 μV
State				
CZ Eyes Closed Theta/Beta (Power)	0.9	▣ 0.7	0.9	0.7–1.6
F3/F4 Eyes Closed Alpha (Magnitude)	1.1	0.7	1.0	0.9–1.1
Symbol Key: ▣ = Possible Artifact, ▽ = Sync Blinks				

The goal is for each screening score to be inside the target range. If a score is below or above the target range it is considered abnormal (too fast if below or too slow if above the



Non-Invasive Scanning and Subtle Energy Testing Lab

target time). An explanation of each of screening score follows. These explanations are provided by p3baseline (www.p3baseline.com).

Physical Reaction time

It is a measure of speed in response to an audible odd tone. This relies on different pathways than the Auditory P300, so physical reaction time may be different than the brain speed.

Trail Making

A standard measure of brain function and includes measures of psychomotor and visual scanning.

Evoked Potentials - Auditory P300

Auditory P300 is a measure of brain response speed and attentional resources. P300 slowing and/or a reduction in voltage may signal changes in cognitive function.

State - CZ Theta/Beta

Theta and Beta frequency bands are affected by cortical arousal and can give insight into how the brain functions. In some people high Theta/Beta ratios at CZ may present as inattention, while others may benefit from cortical arousal.

Researchers have shown that calculating the relative power ratio Theta/Beta at CZ can be used to determine slow-wave disorders, ADHD, interpersonal detachment with qualitative aspects of autistic or Asperger's behavior (3, 4, 5).

State - F3/F4 Alpha

Large differences in Alpha power between the left-front and right-front of the brain have been associated with depression and/or anxiety.

Researchers also discovered that calculating F3/F4 relative power ratio in the Alpha band means processing information in a positive way for an increase while a decrease in the ratio indicated a more negative processing mode (6, 7).

Participant 10

Male, 65, construction consultant/PM. He indicated that he experiences swelling of the ankles or lower extremities and problems or pain in his bones, joints or muscles. He also indicated that he has a history of diabetes or thyroid, kidney or liver disease. For the entire

Non-Invasive Scanning and Subtle Energy Testing Lab

duration of his participation he placed the patch at the back in the middle neck area. At his first visit he indicated that his sense of well-being was 69% on the AIO-VAS (0 = worst you have ever been; 100% = best you have ever been) and his mood was +6 according to the BMIS (the BMIS scale goes from -10 = very unpleasant to +10 = very pleasant). At his second visit, her AIO-VAS score increased to 78% and the BMIS score became +9. At his third visit his AIO-VAS score decreased a bit to 68% and his BMIS score decreased to +8. The Overall Wellness Assessment form indicated that his feeling was as usual at the beginning of his participation and increase to slightly better than usual at the second and third visits.

Scalp Topography Map

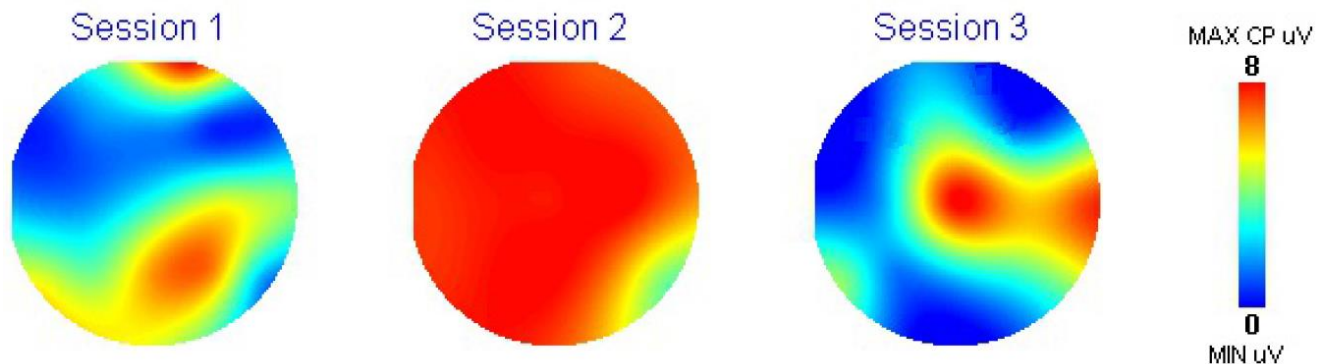

These scalp topographical maps were computed from the 19 EEG channels recorded by the brain mapping system. These maps show the amplitude of the P300 recording for each channel (in microvolts or μV) using a color-coding scale presented on the right side referenced to Session 3 (red is for the maximum amplitude of 8 μV and dark blue for the minimum amplitude of 0 μV). It can be noted that when he came in, his brain was more active at the right parietal region of his brain. His brain became very hyperactive at the second visit (Session 2), after wearing the X39TM patch for 3 weeks. His brain calmed down quite a bit after wearing the X39TM patch for 6 weeks (Session 3). The patterns of brain activity were different too with most activity in the middle and right parts of the brain.

Non-Invasive Scanning and Subtle Energy Testing Lab

Coherence

P300 Eyes Closed Z Scores

Band Ranges
 Theta: 4.5–7.5 Hz
 Alpha: 8.0–13.0 Hz
 Beta: 13.5–20.0 Hz

Color Key



THETA

ALPHA

BETA

Session 1

Z-Scores above 2.0 and below -2.0

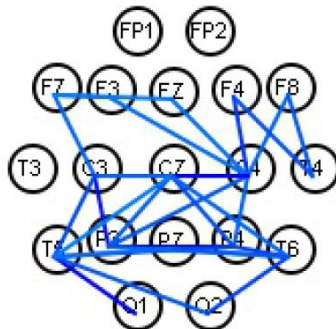

-COHERENCE-

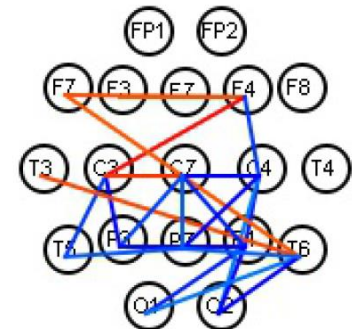
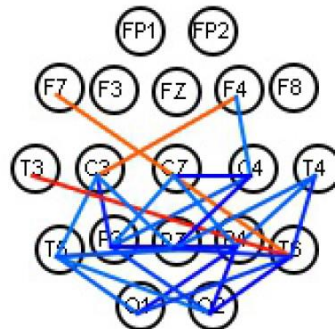

Session 2

Z-Scores above 2.0 and below -2.0

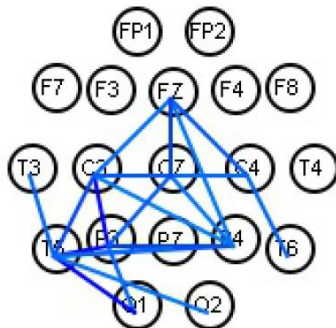

-COHERENCE-

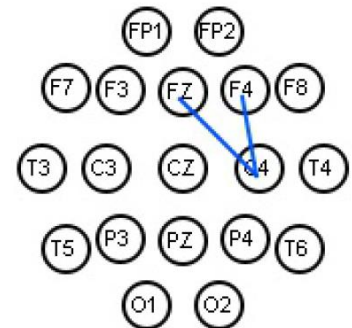
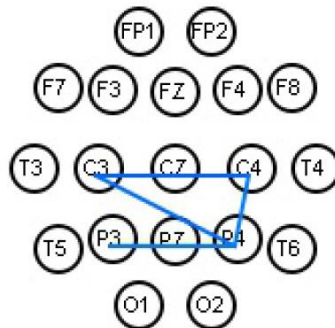

Session 3

Z-Scores above 2.0 and below -2.0

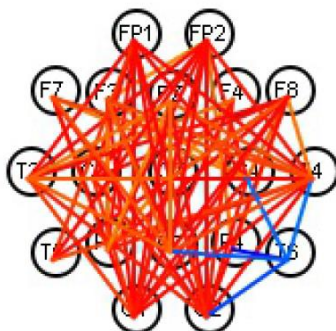

-COHERENCE-

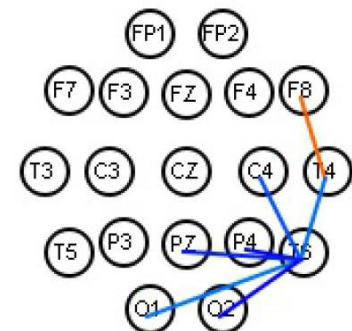
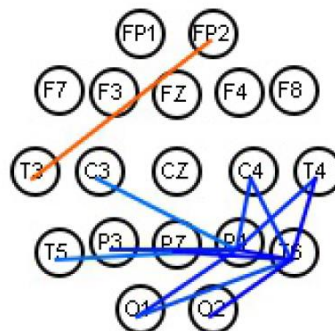



Non-Invasive Scanning and Subtle Energy Testing Lab

EEG coherence can be defined as the normalized cross-power spectrum per frequency of two signals recorded simultaneously at different sites of the scalp. It is a measure of the synchronization between the two signals and may be interpreted as an expression of their functional interaction (1). Coherence reflects how stable the phase relationship is between two electrode sites. Coherence quantifies the degree of interaction or communication, shared information, between brain sites. Hypercoherence is when brain sites are not functioning in efficient interdependent fashion, they have too much “cross-talk”, they are overly connected or locked together. Hypocoherence is called poor inter-site interaction and is associated with diminished cognitive efficiency (2). The red lines between two sites indicate hypercoherence while blue lines reflect hypocoherence. Beta brain waves are normally dominant in a person awake, alert, with normal level of consciousness and brain function. Alpha become dominant in a person with eyes closed, calm, aware and quietly alert. Theta brain waves show up in deep relaxation, meditation and mental imagery (3). Participants were awake with eyes closed during these measurements and so the most relevant results are those presented in the Alpha (relaxation) and Beta (normal brain activity) bands.

At the beginning of his participation (Session 1), Participant 10 had some level of hypocoherence in the occipital (back) of the head at all 3 frequency bands (Beta, Alpha and Theta). After wearing the X39™ patch for 3 weeks (Session 2), there was even less

hypocoherence lines (almost none in the Beta band, indicating normal coherence). After wearing the X39™ patch for 6 weeks (Session 3) there was a small increase in hypocoherence mainly in the occipital part of the brain for Beta and Alpha frequency bands and a huge increase in hypercoherence of the entire head at the Theta frequency band. This could indicate some level of brain healing (3).

Screening Scores

Screening Scores	Session 1	Session 2	Session 3	Target Range
Performance Assessments				
Physical Reaction Time	342 (±48) ms	363 (±58) ms	339 (±46) ms	265–382 ms
Trail Making Test A	80 sec	56 sec	57 sec	64–109 sec
Trail Making Test B	88 sec	69 sec	101 sec	62–119 sec
Evoked Potentials				
Audio P300 Delay	268 ms	272 ms	▣ 260 ms	291–378 ms
Test/Retest Change	-	4 ms	-8 ms	±11 ms
Audio P300 Voltage	7.0 µV	14.3 µV	▣ 7.8 µV	6–15 µV
Test/Retest Change	-	7 µV	1 µV	±2 µV
State				
CZ Eyes Closed Theta/Beta (Power)	0.4	0.5	▣ 1.9	0.7–1.6
F3/F4 Eyes Closed Alpha (Magnitude)	1.2	1.0	1.0	0.9–1.1

Symbol Key: ▣ = Possible Artifact, ▽ = Sync Blinks



Non-Invasive Scanning and Subtle Energy Testing Lab

The goal is for each screening score to be inside the target range. If a score is below or above the target range it is considered abnormal (too fast if below or too slow if above the target time). An explanation of each of screening score follows. These explanations are provided by p3baseline (www.p3baseline.com).

Physical Reaction time

It is a measure of speed in response to an audible odd tone. This relies on different pathways than the Auditory P300, so physical reaction time may be different than the brain speed.

Trail Making

A standard measure of brain function and includes measures of psychomotor and visual scanning.

Evoked Potentials - Auditory P300

Auditory P300 is a measure of brain response speed and attentional resources. P300 slowing and/or a reduction in voltage may signal changes in cognitive function.

State - CZ Theta/Beta

Theta and Beta frequency bands are affected by cortical arousal and can give insight into how the brain functions. In some people high Theta/Beta ratios at CZ may present as inattention, while others may benefit from cortical arousal.

Researchers have shown that calculating the relative power ratio Theta/Beta at CZ can be used to determine slow-wave disorders, ADHD, interpersonal detachment with qualitative aspects of autistic or Asperger's behavior (3, 4, 5).

State - F3/F4 Alpha

Large differences in Alpha power between the left-front and right-front of the brain have been associated with depression and/or anxiety.

Researchers also discovered that calculating F3/F4 relative power ratio in the Alpha band means processing information in a positive way for an increase while a decrease in the ratio indicated a more negative processing mode (6, 7).

Non-Invasive Scanning and Subtle Energy Testing Lab

Participant 11

Female, 66, manager of a real estate office. For the entire duration of her participation she placed the patch at the back of the neck. At her first visit she indicated that her sense of well-being was 100% on the AIO-VAS (0 = worst you have ever been; 100% = best you have ever been) and her mood was +9 according to the BMIS (the BMIS scale goes from -10 = very unpleasant to +10 = very pleasant). At her second visit, her AIO-VAS score decreased to 53% and the BMIS score stayed at +10 (she indicated she had no sleep the night before and felt a bit tired). At her third visit her AIO-VAS score increased to 89% and her BMIS score stayed at +10. The Overall Wellness Assessment form indicated that her feeling was a lot better than usual at the first and third visits and slightly better than usual at her second visit.

Scalp Topography Map

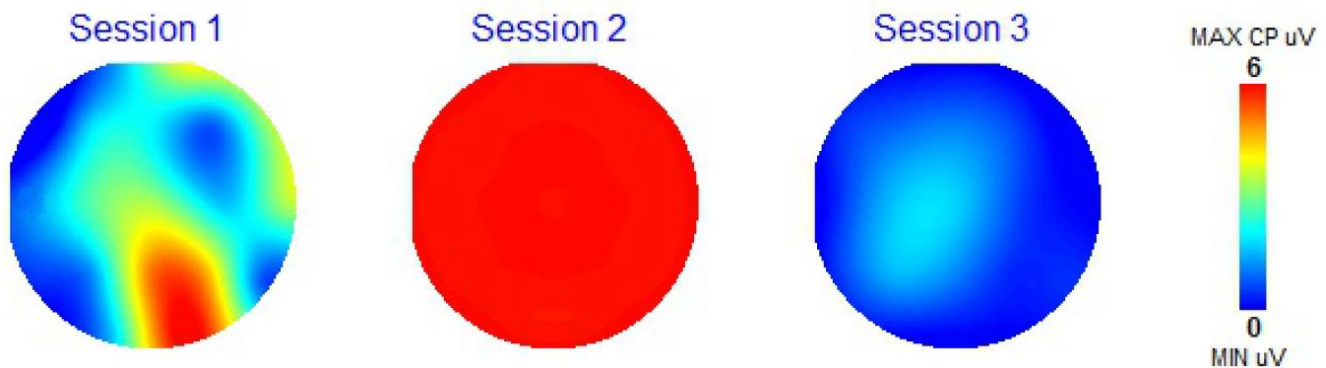

These scalp topographical maps were computed from the 19 EEG channels recorded by the brain mapping system. These maps show the amplitude of the P300 recording for each channel (in microvolts or μ V) using a color-coding scale presented on the right side referenced to Session 3 (red is for the maximum amplitude of 6 μ V and dark blue for the minimum amplitude of 0 μ V). It can be noted that when she came in, the right occipital region of her brain was hyperactive. Her brain became extremely hyperactive at the second visit (Session 2), after wearing the X39™ patch for 3 weeks. Her brain calmed down dramatically after wearing the X39™ patch for 6 weeks (Session 3).

Non-Invasive Scanning and Subtle Energy Testing Lab

Coherence

P300 Eyes Closed Z Scores

Band Ranges
 Theta: 4.5–7.5 Hz
 Alpha: 8.0–13.0 Hz
 Beta: 13.5–20.0 Hz

Color Key



THETA

ALPHA

BETA

Session 1

Z-Scores above 2.0 and below -2.0

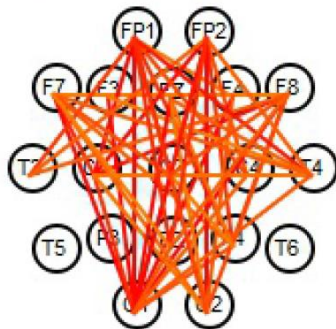

-COHERENCE-

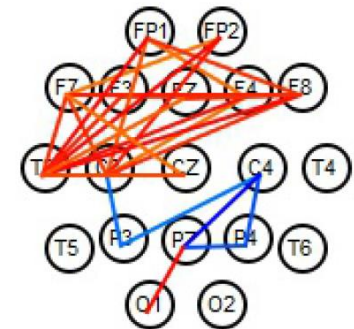
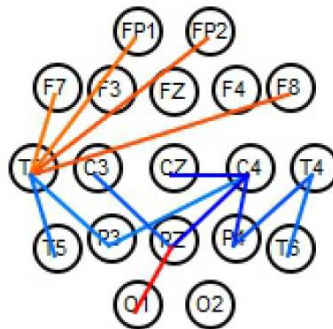

Session 2

Z-Scores above 2.0 and below -2.0

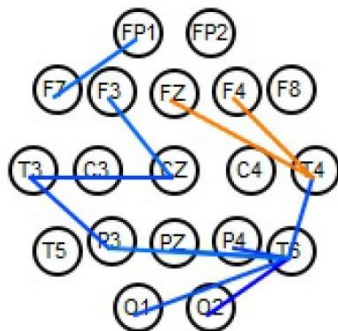

-COHERENCE-

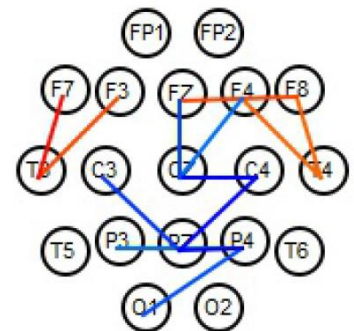
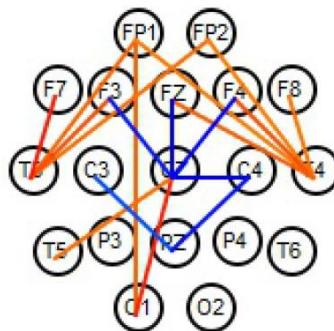

Session 3

Z-Scores above 2.0 and below -2.0

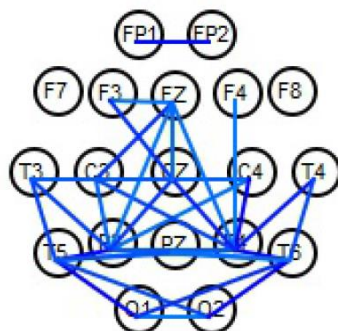

-COHERENCE-

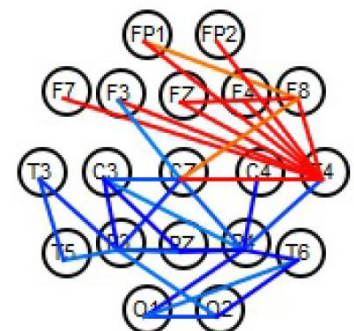
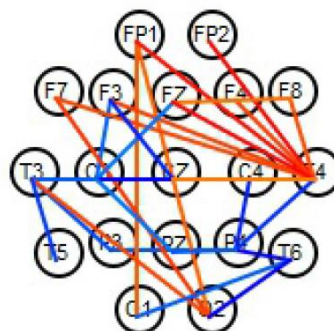



Non-Invasive Scanning and Subtle Energy Testing Lab

EEG coherence can be defined as the normalized cross-power spectrum per frequency of two signals recorded simultaneously at different sites of the scalp. It is a measure of the synchronization between the two signals and may be interpreted as an expression of their functional interaction (1). Coherence reflects how stable the phase relationship is between two electrode sites. Coherence quantifies the degree of interaction or communication, shared information, between brain sites. Hypercoherence is when brain sites are not functioning in efficient interdependent fashion, they have too much “cross-talk”, they are overly connected or locked together. Hypocoherence is called poor inter-site interaction and is associated with diminished cognitive efficiency (2). The red lines between two sites indicate hypercoherence while blue lines reflect hypocoherence. Beta brain waves are normally dominant in a person awake, alert, with normal level of consciousness and brain function. Alpha become dominant in a person with eyes closed, calm, aware and quietly alert. Theta brain waves show up in deep relaxation, meditation and mental imagery (3). Participants were awake with eyes closed during these measurements and so the most relevant results are those presented in the Alpha (relaxation) and Beta (normal brain activity) bands.

At the beginning of her participation (Session 1), Participant 11 had a mix of hypercoherence (mainly Beta and Theta) and hypocoherence (occipital region in the Alpha band). After wearing the X39™ patch for 3 weeks (Session 2), most of the hypercoherence disappeared

(except for a little bit mainly in the Alpha frequency band). The lower number of hypercoherence or hypocoherence is an indication that the brain coherence is becoming more normal). After wearing the X39™ patch for 6 weeks (Session 3) hypercoherence reappeared in the frontal region of the brain, mainly in Beta and Alpha frequency bands while hypocoherence appeared in the occipital region of the brain in the Theta frequency band.

Screening Scores

Screening Scores	Session 1	Session 2	Session 3	Target Range
Performance Assessments				
Physical Reaction Time	375 (±90) ms	442 (±94) ms	455 (±75) ms	267–384 ms
Trail Making Test A	78 sec	85 sec	72 sec	66–112 sec
Trail Making Test B	226 sec	149 sec	253 sec	63–122 sec
Evoked Potentials				
Audio P300 Delay	492 ms	N/A	N/A	293–380 ms
Test/Retest Change	-	N/A	N/A	±11 ms
Audio P300 Voltage	5.0 µV	0.0 µV	2.6 µV	6–15 µV
Test/Retest Change	-	N/A	-2 µV	±2 µV
State				
CZ Eyes Closed Theta/Beta (Power)	1.1	0.6	▣ 0.9	0.6–1.6
F3/F4 Eyes Closed Alpha (Magnitude)	1.3	1.0	1.3	0.9–1.1

Symbol Key: ▣ = Possible Artifact, ▽ = Sync Blinks



Non-Invasive Scanning and Subtle Energy Testing Lab

The goal is for each screening score to be inside the target range. If a score is below or above the target range it is considered abnormal (too fast if below or too slow if above the target time). An explanation of each of screening score follows. These explanations are provided by p3baseline (www.p3baseline.com).

Physical Reaction time

It is a measure of speed in response to an audible odd tone. This relies on different pathways than the Auditory P300, so physical reaction time may be different than the brain speed.

Trail Making

A standard measure of brain function and includes measures of psychomotor and visual scanning.

Evoked Potentials - Auditory P300

Auditory P300 is a measure of brain response speed and attentional resources. P300 slowing and/or a reduction in voltage may signal changes in cognitive function.

State - CZ Theta/Beta

Theta and Beta frequency bands are affected by cortical arousal and can give insight into how the brain functions. In some people high Theta/Beta ratios at CZ may present as inattention, while others may benefit from cortical arousal.

Researchers have shown that calculating the relative power ratio Theta/Beta at CZ can be used to determine slow-wave disorders, ADHD, interpersonal detachment with qualitative aspects of autistic or Asperger's behavior (3, 4, 5).

State - F3/F4 Alpha

Large differences in Alpha power between the left-front and right-front of the brain have been associated with depression and/or anxiety.

Researchers also discovered that calculating F3/F4 relative power ratio in the Alpha band means processing information in a positive way for an increase while a decrease in the ratio indicated a more negative processing mode (6, 7).

Participant 12

Male, 69, photographer. He indicated that he experiences problems or pain in his bones, joints or muscles. For the entire duration of his participation he placed the patch three inches

Non-Invasive Scanning and Subtle Energy Testing Lab

below the navel. At his first visit he indicated that his sense of well-being was 43% on the AIO-VAS (0 = worst you have ever been; 100% = best you have ever been) and his mood was +7 according to the BMIS (the BMIS scale goes from -10 = very unpleasant to +10 = very pleasant). At his second visit, his AIO-VAS score increased to 57% and the BMIS score became +4. At his third visit his AIO-VAS score decreased to 17% and his BMIS score became to +5. He indicated that he had a bad cold for the last 7 days of his participation. The Overall Wellness Assessment form indicated that his feeling was as usual during the entire time of his participation. He also indicated that he has not noticed any physiological or psychological change during the entire time of his participation.

Scalp Topography Map

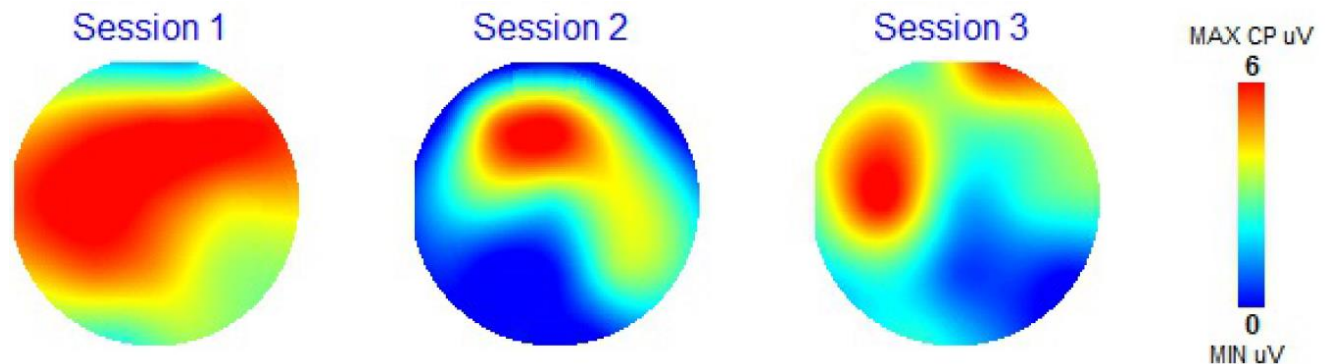

These scalp topographical maps were computed from the 19 EEG channels recorded by the brain mapping system. These maps show the amplitude of the P300 recording for each channel (in microvolts or μV) using a color-coding scale presented on the right side referenced to Session 3 (red is for the maximum amplitude of 6 μV and dark blue for the minimum amplitude of 0 μV). It can be noted that when he came in, his brain was hyperactive. His brain calmed down dramatically at the second visit (Session 2), after wearing the X39™ patch for 3 weeks and it remained within the normal activity range after wearing the X39™ patch for 6 weeks (Session 3).

Non-Invasive Scanning and Subtle Energy Testing Lab

Coherence

P300 Eyes Closed Z Scores

Band Ranges
 Theta: 4.5–7.5 Hz
 Alpha: 8.0–13.0 Hz
 Beta: 13.5–20.0 Hz

Color Key



THETA

ALPHA

BETA

Session 1

Z-Scores above 2.0 and below -2.0

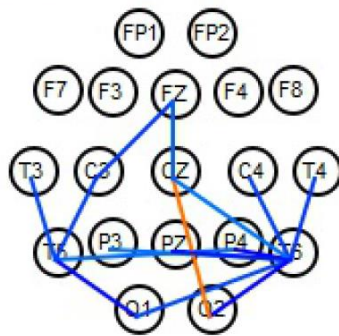

-COHERENCE-

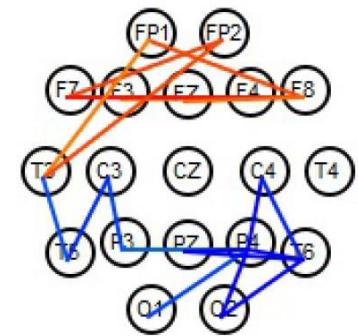
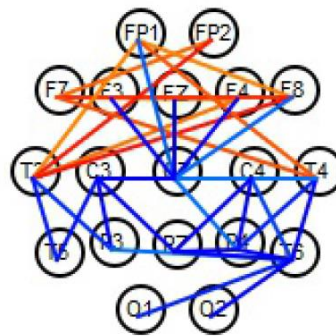

Session 2

Z-Scores above 2.0 and below -2.0

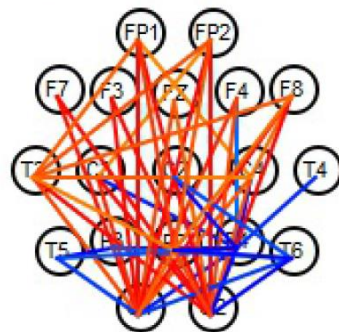

-COHERENCE-

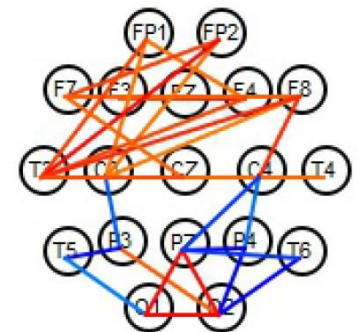
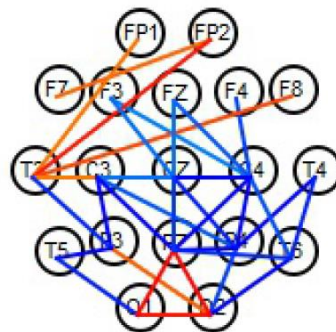

Session 3

Z-Scores above 2.0 and below -2.0

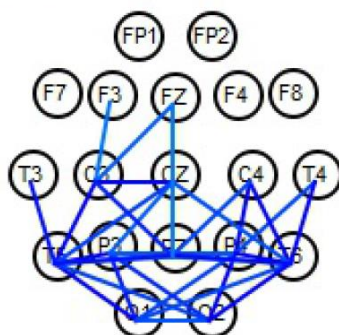

-COHERENCE-

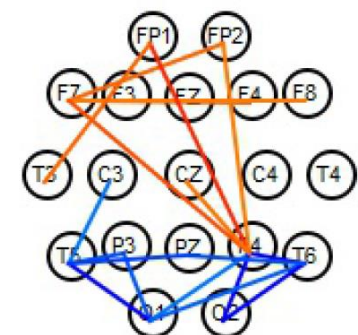
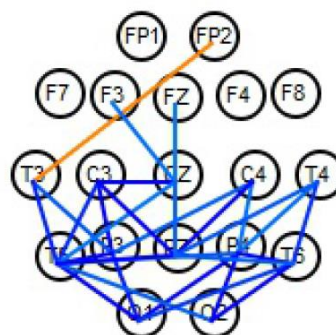



Non-Invasive Scanning and Subtle Energy Testing Lab

EEG coherence can be defined as the normalized cross-power spectrum per frequency of two signals recorded simultaneously at different sites of the scalp. It is a measure of the synchronization between the two signals and may be interpreted as an expression of their functional interaction (1). Coherence reflects how stable the phase relationship is between two electrode sites. Coherence quantifies the degree of interaction or communication, shared information, between brain sites. Hypercoherence is when brain sites are not functioning in efficient interdependent fashion, they have too much “cross-talk”, they are overly connected or locked together. Hypocoherence is called poor inter-site interaction and is associated with diminished cognitive efficiency (2). The red lines between two sites indicate hypercoherence while blue lines reflect hypocoherence. Beta brain waves are normally dominant in a person awake, alert, with normal level of consciousness and brain function. Alpha become dominant in a person with eyes closed, calm, aware and quietly alert. Theta brain waves show up in deep relaxation, meditation and mental imagery (3). Participants were awake with eyes closed during these measurements and so the most relevant results are those presented in the Alpha (relaxation) and Beta (normal brain activity) bands.

At the beginning of his participation (Session 1), Participant 12 had a mix of hypercoherence (mainly Beta and Alpha, frontal region) and hypocoherence (occipital region in all frequency bands). After wearing the X39™ patch for 3 weeks (Session 2), most of the hypercoherence disappeared in the Alpha frequency band, stayed about the same in the Beta frequency band

and increased quite a bit in the Theta frequency band. (except for a little bit mainly in the Alpha frequency band). The lower number of hypercoherence or hypocoherence is an indication that the brain coherence is becoming more normal). After wearing the X39™ patch for 6 weeks (Session 3) hypercoherence disappeared (except in the frontal region in the Beta frequency band), while hypocoherence appeared in the occipital region of the brain in all frequency bands.

Screening Scores

Screening Scores	Session 1	Session 2	Session 3	Target Range
Performance Assessments				
Physical Reaction Time	415 (±91) ms	375 (±64) ms	384 (±82) ms	271–391 ms
Trail Making Test A	95 sec	64 sec	67 sec	71–120 sec
Trail Making Test B	160 sec	153 sec	207 sec	68–131 sec
Evoked Potentials				
Audio P300 Delay	296 ms	340 ms	312 ms	298–388 ms
Test/Retest Change	-	44 ms	16 ms	±11 ms
Audio P300 Voltage	8.7 µV	3.1 µV	6.0 µV	6–15 µV
Test/Retest Change	-	-6 µV	-3 µV	±2 µV
State				
CZ Eyes Closed Theta/Beta (Power)	■ 0.6	■ 2.1	0.7	0.6–1.5
F3/F4 Eyes Closed Alpha (Magnitude)	1.1	1.3	1.1	0.9–1.1

Symbol Key: ■ = Possible Artifact, ▽ = Sync Blinks



Non-Invasive Scanning and Subtle Energy Testing Lab

The goal is for each screening score to be inside the target range. If a score is below or above the target range it is considered abnormal (too fast if below or too slow if above the target time). An explanation of each of screening score follows. These explanations are provided by p3baseline (www.p3baseline.com).

Physical Reaction time

It is a measure of speed in response to an audible odd tone. This relies on different pathways than the Auditory P300, so physical reaction time may be different than the brain speed.

Trail Making

A standard measure of brain function and includes measures of psychomotor and visual scanning.

Evoked Potentials - Auditory P300

Auditory P300 is a measure of brain response speed and attentional resources. P300 slowing and/or a reduction in voltage may signal changes in cognitive function.

State - CZ Theta/Beta

Theta and Beta frequency bands are affected by cortical arousal and can give insight into how the brain functions. In some people high Theta/Beta ratios at CZ may present as inattention, while others may benefit from cortical arousal.

Researchers have shown that calculating the relative power ratio Theta/Beta at CZ can be used to determine slow-wave disorders, ADHD, interpersonal detachment with qualitative aspects of autistic or Asperger's behavior (3, 4, 5).

State - F3/F4 Alpha

Large differences in Alpha power between the left-front and right-front of the brain have been associated with depression and/or anxiety.

Researchers also discovered that calculating F3/F4 relative power ratio in the Alpha band means processing information in a positive way for an increase while a decrease in the ratio indicated a more negative processing mode (6, 7).

Statistical Analysis

For each session, Physical Reaction Time, Trail Making Test A and B, Audio P300 Delay and Voltage, CZ Theta/Beta, AIO-VAS well-being score and BMIS mood score were averaged



Non-Invasive Scanning and Subtle Energy Testing Lab

over all participants. The means were compared between sessions for statistical significance using t-test or a non-parametric equivalent. As shown in the table below significant results were obtained for Physical Reaction Time and Audio P300 Voltage. According to the table, physical reaction time increased significantly at Session 2 compared to Session 1. There was no significant difference between Session 3 and Session 1 suggesting a return of the reaction time to that before the start of the experiment. Audio P300 Voltage decreased significantly at Session 2 and Session 3 compared to Session 1. The usual critical value of 0.05 was used to determine statistical significance (significant results are presented in red in the table).

	Physical Reaction Time (ms)			Audio P300 Voltage (μ V)		
	Session 1	Session 2	Session 3	Session 1	Session 2	Session 3
Ave.:	348	371	358	12.1	6.9	7.9
SD:	49.6	55.1	63.3	5.4	4.5	3.7
p=		0.016	0.337		0.004	0.017
p(2-3)=			0.143			0.466

Discussion

All participants showed dramatic changes in their scalp topographic maps reporting the amplitude of the P300 recording for each channel and also in their coherence maps. According to their coherence maps, the majority of participants started with an over active brain (#1, #2, #3, #4, #5, #6, #7, #11 and #12) and their brain calmed down significantly after 3 weeks of wearing the X39™ patch. For #6 and #7 the brain became very active again after 6 weeks. For #12 the brain became more active after 3 weeks and calmed down only after 6 weeks. Participant 8 experienced a great increase in brain activity after 3 weeks. Her brain calmed down significantly and became more normal (i.e. less high or low coherences) after 6 weeks. Participants 9 and 10 experienced a dramatic increase in brain activity only at the 6 weeks visit. Several participants reported various improvements (#1, #3, #7, #8) and most of them reported feeling slightly better or a lot better at the end of their participation (#1, #2, #3, #5, #7, #8, #10, #11).

The statistically significant increase in physical reaction time at Session 2 may be due to the effect of the X39™ patch on the physiology of the participants. The fact that the physical reaction time returned to the initial average value after 6 weeks suggests that there is a temporary physiological effect due to the X39™ patch that readjusts itself to a normal level within a 6-week period. The significantly lower average values of Audio P300 Voltage at Session 2 and at Session 3 compared to Session 1, coupled with the coherence results, suggest that the initial Audio P300 Voltage was high and reflects a brain that is hyperactive. Application of a X39™ patch for 3 weeks brought the Audio P300 Voltage to a normal level and that levels stayed normal at the end of 6 weeks.



Non-Invasive Scanning and Subtle Energy Testing Lab

Conclusion

All participants showed dramatic changes in their scalp topographic maps reporting the amplitude of the P300 recording for each channel and also in their coherence maps. According to their coherence maps, the majority of participants started with an over active brain and their brain calmed down significantly after 3 weeks of wearing the X39™ patch. Several participants reported various notable improvements and most participants reported feeling slightly better or a lot better at the end of their participation.

There was a statistically significant increase in physical reaction time at Session 2 that may be due to the effect of the X39™ patch on the physiology of the participants. The fact that the physical reaction time returned to the initial average value after 6 weeks suggests that there is a temporary physiological effect due to the X39™ patch that readjusts itself to a normal level within a 6-week period. The significantly lower average values of Audio P300 Voltage at Session 2 and at Session 3 compared to Session 1, coupled with the coherence results, suggest that the initial Audio P300 Voltage was high and reflects a hyperactive brain. Application of a X39™ patch for 3 weeks brought the Audio P300 Voltage to a normal level and that level stayed normal until the end of the 6-week duration of the study.

References

- 1- Locatelli, T., Cursi, M., Liberati, D., Franceschi, M. & Comi, G. (1998) EEG coherence in Alzheimer's disease. *Neurophysiology*, 106, 229-237.
- 2- Warner, S. (2013) Cheat Sheet for Neurofeedback. Retrieved on 4/24/2019 from: <http://www.stresstherapysolutions.com/uploads/STSCheatSheetoftheBrain.pdf>
- 3- Colgin, L.L. (2013) Mechanisms and Functions of Theta Rhythms. *Annual Review of Neuroscience*, 36, 295-312.
- 4- Monastra, V. J., Lubar, J. F., Linden, M., VanDeusen, P., Green, G., Wing, W., Phillips, A., & Fenger, T. N. (1999). Assessing attention deficit hyperactivity disorder via quantitative electroencephalography: an initial validation study. *Neuropsychology*, 13(3), 424-433.
- 5- Snyder, S., & Hall, J. (2006). A meta-analysis of quantitative EEG power associated with attention-deficit hyperactivity disorder. *Journal of Clinical Neurophysiology*, 23 (5), 440-455.
- 6- Thibodeau, R., Jorgensen, R. S., & Kim, S. (2006). Depression, anxiety, and resting frontal EEG asymmetry: A meta-analytic review. *Journal of Abnormal Psychology*, 115 (1), 715-729.
- 7- Imotion. (2017) Frontal Asymmetry 101 – How to Get Insights on Motivation and Emotions from EEG. Retrieved on 4/24/2019 from: <https://imotions.com/blog/frontal-asymmetry-101-get-insights-motivation-emotions-eeeg/>



Non-Invasive Scanning and Subtle Energy Testing Lab

APPENDIX A

Gaétan Chevalier, Ph.D.,

Biographical Sketch

Dr. Gaétan Chevalier received his Ph.D. from the University of Montréal in Atomic Physics and Laser Spectroscopy in 1988. After 4 years of research at UCLA in the field of nuclear fusion, he became professor and Director of Research at the California Institute for Human Science (CIHS) in 1993 where, for 10 years, he conducted research projects on human physiology and electrophysiology as well as being Director of the Life Physics Department and Research Director. Dr. Chevalier is currently Lead Faculty at CIHS, Visiting Scholar in the Department of Family Medicine and Public Health at UCSD, and he has been Director of Research at Psy-Tek Labs since June 2010.



Non-Invasive Scanning and Subtle Energy Testing Lab

APPENDIX B

Mary D. Clark, Ph.D.,

Biographical Sketch

Mary D. Clark, Ph.D. is a licensed psychologist in Arizona, and is a licensed marriage family therapist and licensed educational psychologist in California. She maintains both a private practice and a healing practice in Encinitas, California. Mary is a Certified Energy Healing Instructor, a Senior Certified Energy Healer, and past coordinator of the Energy Healing Certification Program for the central and western states. She has practiced and taught Energy Healing for over 10 years,